

FLORIDA 4-H

Area & State Horse Shows



Florida Cooperative Extension Service
IFAS, University of Florida, Gainesville
Andra Johnson, Dean and Director for Extension

STATEMENT OF AUTHORITY

This rulebook is developed by the State 4-H Horse Advisory Committee comprised of agents and volunteer leaders representing each of the three areas in the state in cooperation with Extension 4-H and Horse Specialists.

The State Extension Horse Specialist is entrusted by Extension Administration with the responsibility of interpreting these rules and ensuring the adherence of said rules. In the case of county and area shows, this authority may be delegated to the show management of said shows.

Those individuals desiring input into the formulation of rules, regulations, and procedures should contact volunteers or agents from their area who serve on the State 4-H Advisory Committee.

The Dean for Extension is responsible for coordinating statewide Florida's Extension program.

TABLE OF CONTENTS

PHILOSOPHY AND GOALS OF THE FLORIDA 4-H HORSE PROGRAM.....	i
RULES AND REGULATORY CHANGES.....	ii
CLASS LIST.....	iii
GENERAL RULES, REGULATIONS, AND PROCEDURES.....	1
CONTEST RULES, REGULATIONS, AND PROCEDURES.....	7
BIT RULES.....	11
CLASSES.....	16
CONFORMATION OR IN-HAND CLASSES.....	16
SHOWMANSHIP and GROUND HANDLING CLASSES (All Divisions)	17
WESTERN DIVISION	22
Western Pleasure.....	22
Western Horsemanship	23
Western Trail	26
RANCH DIVISION	29
Ranch Riding.....	29
Ranch Trail	47
Ranch Reining.....	50
Ranch Roping.....	60
Working Cow Horse, Boxing Only	61
Ranch Rail	63
SPEED EVENTS DIVISION.....	64
Keyhole Race.....	66
Stake Race.....	66
Pole Bending.....	67
Barrel Race.....	67
HUNTER DIVISION	68
Hunter Under Saddle	69
Hunt Seat Equitation On The Flat.....	69
Hunter Course Heights and Set-up.....	72
Hunter Hack.....	74
Working Hunter	75
Equitation Over Fences.....	76
Handy Hunter	77
DRESSAGE DIVISION.....	78
Western Dressage.....	78
Training & First Level Dressage	81
GENERAL HORSE SHOW MANAGEMENT CONSIDERATIONS.....	84
JUDGE'S RESPONSIBILITY	87

PHILOSOPHY AND GOALS OF THE FLORIDA 4-H HORSE PROGRAM

The purpose of the 4-H horse program is to provide young people an opportunity to participate in a series of activities designed to improve citizenship, sportsmanship, horsemanship, character, competitive spirit, discipline, and responsibility while creating an atmosphere for learning and awareness of the life about us.

If one takes time to study this statement, the goals and implications are awesome. It is not anticipated that a child would progress at the same rate for all these objectives; it is expected that given the proper motivation and provided good leadership by leaders, parents, and agents, there would be improvement in all areas. Many times the recognition by the 4-H'ers that they could improve in these areas is a significant accomplishment.

Most 4-H'ers electing this project will already have a significant interest in and even a passionate love for the animal. It is the leaders' responsibility to utilize this interest to accomplish the project objectives. Though the objectives may be arranged in a different order, you will notice the first objective is not horsemanship. Horsemanship, in the broadest sense, is an important facet of the 4-H horse program, but it should be understood that the horse is but a tool to be used in the development and education of the child. There are over fifty major project areas available in 4-H and all of them have as objectives to make better citizens of these youth, to increase their knowledge in a particular subject matter area, and to inspire them to explore other areas.

Horse shows are not the major objective of this program, and any leader or agent that professes this, either out of actual belief or to persuade someone to join a 4-H club, is certainly in error. In doing this, they would most certainly be setting themselves and the club up for disappointment and possible failure. This is not to minimize the importance of horse shows in helping to achieve our goals, but it must be understood we are in the business of education. There are many opportunities to show elsewhere and, also, it is quite possible there will be many youth in a club that are not interested in showing. They may be interested in one or more of the many forms of trail riding, rodeo, breeding and production, or other activities involving the use of a horse.

When thinking about the horse program and its objectives, one should certainly realize the potential that participation in horse judging, public speaking, and method demonstrations has in helping to achieve said goals. Participation in these activities can help a youth improve in many areas, as well as gain a better education.

In summary, there is a need for all aspects of the current 4-H horse program, and it is hoped that you as leaders and agents will encourage participation of your club in all these areas.

E. L. Johnson

CHANGES FOR 2026

For edited rules, **bold** = added ~~strikeout~~ = removed.

General & Contest Rules:

High Point eligibility has been adjusted (pg. 6) ...**"For a horse/rider combination to be eligible for a division high point, they must show in a minimum of two (2) classes listed within that division."**

Bit rules for Speed Division Only classes were changed, bullet points 1 & 2 (pg. 11) ...**"1. Mouthpieces must be between 1/4" to 3/4" in diameter, measured 1" from the cheek. 2. Bits with a slow twist mouthpiece are allowed**

Class Rules:

Legal tack requirements were adjusted for appropriate Ranch Division (pg. 28) ...**" Roping reins are only permitted in Ranch Roping (Class 20)."**

Use of standing martingales in Hunter Division classes was clarified (pg. 69-70) ...**"Standing martingales are optional in over fence classes (Working Hunter, Equitation Over Fences, and Handy Hunter) except for Hunter Hack. Martingales are not allowed in any under saddle flat classes, or classes that have a flat portion such as Hunter Hack."**

AREA and STATE 4-H HORSE SHOW CLASS LIST, 2026

WESTERN DIVISION

1. Stock Type Mares and Geldings, 14.2 hands and under
2. Stock Type Mares, over 14.2 hands
3. Stock Type Geldings, over 14.2 hands
4. Jr. Western Showmanship
5. Sr. Western Showmanship
6. Western Pleasure Pony, 14.2 hands and under
7. Jr. Western Pleasure, over 14.2 hands
8. Sr. Western Pleasure, over 14.2 hands
9. Jr. Western Horsemanship
10. Sr. Western Horsemanship
11. Jr. Western Trail
12. Sr. Western Trail

RANCH DIVISION

13. Jr. Ranch Ground Handling
14. Sr. Ranch Ground Handling
15. Jr. Ranch Riding
16. Sr. Ranch Riding
17. Jr. Ranch Trail
18. Sr. Ranch Trail
19. Ranch Reining
20. Ranch Roping
21. Working Cow Horse, Boxing Only
22. Jr. Ranch Rail
23. Sr. Ranch Rail

SPEED EVENTS DIVISION

24. Jr. Speed Events Ground Handling
25. Sr. Speed Events Ground Handling
26. Jr. Keyhole Race
27. Sr. Keyhole Race
28. Jr. Stake Race
29. Sr. Stake Race
30. Jr. Pole Bending
31. Sr. Pole Bending
32. Jr. Barrel Race
33. Sr. Barrel Race

HUNTER DIVISION

34. Hunter Type Mares and Geldings, 14.2 hands and under
 35. Hunter Type Mares, over 14.2 hands
 36. Hunter Type Geldings, over 14.2 hands
 37. Jr. Hunter Showmanship
 38. Sr. Hunter Showmanship
 39. Pony Hunter Under Saddle, 14.2 hands and under
 40. Jr. Hunter Under Saddle, over 14.2 hands
 41. Sr. Hunter Under Saddle, over 14.2 hands
 42. Jr. Hunt Seat Equitation
 43. Sr. Hunt Seat Equitation
 44. Hunter Hack
- Low Section: 2'3"
45. Low Working Hunter
 46. Low Equitation over Fences
 47. Low Handy Hunter

Medium/High Section: 2'6"/2'9"

48. Medium/High Working Hunter
49. Medium/High Equitation over Fences
50. Medium/High Handy Hunter

DRESSAGE DIVISION

51. Jr. Western Dressage, WDAA 2022 Basic, TOC**
52. Sr. Western Dressage, WDAA 2022 Basic, TOC**
53. Jr. Training Level Dressage, USEF 2023, TOC**
54. Sr. Training Level Dressage, USEF 2023, TOC**
55. First Level Dressage, USEF 2023, TOC**

***Medium/High Section**

Entrants will choose their height for each class at time of registration (and may change at gate *before* class starts).

****TOC = Test of Choice**

Dressage entrants may choose any test within the stated level of each class.

GENERAL RULES, REGULATIONS, AND PROCEDURES

This handbook of rules is intended to establish uniform regulations and procedures for qualifying participants in the State 4-H Horse Show Program. These rules will govern the Florida Area and State 4-H Horse Shows. It is suggested that 4-H county shows adopt this rule book to govern the operation of their shows.

Only the horsemanship phase of the 4-H program is affected by these rules and only classes that fit the large majority of 4-H members are offered. Counties are encouraged to develop 4-H horse programs according to local needs and situations, and to include a wide range of educational activities.

These rules are in effect for the 2026 4-H show season. **Failure to comply with the rules, regulations and procedures in this book may result in disqualification and/or disciplinary action.** Be sure to check for changes each year.

CERTIFICATION

A County Extension Agent must certify the eligibility of the 4-H member as having met minimum project requirements and ownership, age, sex, and registration status of each horse. This information must be on file at the respective County Extension Offices by January 1 (see #2 under Eligibility below).

CURRENT STATE 4-H AGE REQUIREMENT

The minimum age of a 4-H'er in the Horse program is 8 years old and the maximum age is 18 years old, or completion of high school, whichever comes first. Ages are as of September 1 of the current 4-H year.

JUNIOR AND SENIOR DIVISIONS

- Juniors are 8-10 as of September 1 of the current 4-H year.
- Intermediates (11-13 as of September 1 of the current 4-H year) have the option of competing in either the Junior or Senior division. Intermediates may qualify for Regionals with the Seniors provided they compete and qualify in the Senior Division in both the Area and State shows.
- Seniors must be 14 years old on or before September 1 of the current 4-H year.

Age Divisions and eligibility for Regionals qualifying:

- Senior Division (including Intermediates showing as Seniors): Seniors will qualify for Regionals in point-earning order until all allotted spaces are filled, or until there are no more eligible Seniors.
- Junior Division (including Intermediates showing as Juniors): Top-10 Juniors will qualify for Regionals. In the event that there are still allotted spaces available after all eligible Seniors have been offered, remaining spaces *may* be offered to Junior division riders beyond the top-10 in points-earned order.

ELIGIBILITY OF PARTICIPANTS AND HORSES

1. Participant must be an active and current 4-H club member, meeting all the membership requirements established by the club and county program.

2. Participant must manage at least one horse of any age or breed as a 4-H horsemanship project. The horse(s) must be owned or leased by the 4-H member, the member's parents, brother, sister, or legal guardian and certified as a 4-H project by January 1 of the current 4-H year.
3. "Horses" eligible to enter include horses, ponies, miniature horses, and mules. Donkeys (full size or miniature) are not eligible to compete in the Area and State Horse Shows.
4. Per horse industry standard, a horse's birth date will be considered January 1 of its foaling year, regardless of its actual foaling date. Therefore, age of a horse is as of January 1 of the calendar year in which the show is held.
5. Counties may allow for replacement of a project horse or pony prior to the area show if the project horse or pony is certified unsound by a veterinarian and approved by the County Extension Agent and the 4-H Horse Club leaders. If the unsound horse is the exhibitor's only entry, the replacement horse must meet all 4-H project horse criteria other than the January 1 ownership and certification date. If the unsound horse is one of multiple entries by an exhibitor, the replacement horse must meet all 4-H project horse criteria including the January 1 ownership and certification date. Substitution requests must be made by the County Agent to the Area Show Chair according to each Area's advertised substitution deadline.
6. Provisional qualifications for state show participation may be granted for extenuating circumstances to individuals in their final year of eligibility. Issues relative to the project animal (lameness, colic, death, etc.) will not be considered extenuating circumstances. Also, "extenuating circumstances" does not apply to social events such as prom, grad night, etc. To make application, the potential exhibitor must contact the State Extension Horse Specialist prior to the date the area show is held in which they would normally compete.
7. Leasing will be permitted with the approval of the county agent and/or advisory committee. A notarized lease form 4H HSF 01 or comparable equivalent lease document must be on file at the County Extension Office by January 1 for the horse to be eligible to participate in Florida 4-H area or state shows. A maximum of three 4-H members may lease and show a single horse.
8. The 4-H member must keep and submit to the county agent a horse record book (4H418 or 4H HSR 02) on project horses to be eligible to compete in area and state shows. Agents are advised that it is their responsibility to certify that a member has an up-to-date record book and has met the requirements to compete above county level.

9. Research has shown that health complications, such as heat stress, stress of traveling, and showing can be exacerbated at low body condition scores. Due to concerns for animal welfare and the objective of 4-H to educate and promote quality animal husbandry; horses, ponies and/or mules shall not be shown with a body condition score of less than 4 based on the Henneke scale (ribs easily discernible, tops of spinous process easily discernible, tailhead prominent with hook bones easily discernible, withers accentuated, and neck obviously thin). If you have questions about the body condition score of your horse, or if you are not sure your horse will pass inspection, please contact your Area Advisory representative before the Area show. The Area Horse Show Chair

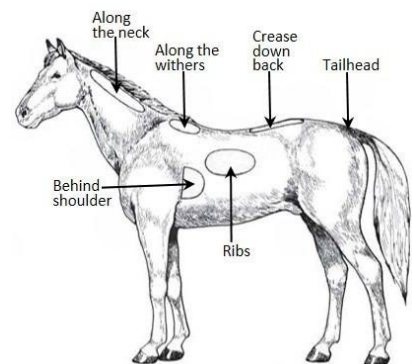

and/or the State Horse Show Superintendent or their designee will assess animals in question. If there is a thin horse, the Advisory committee will make a final decision whether or not to disqualify the animal.

Horse Body Condition Scores and Descriptions (<i>Adapted from Henneke et al., 1983</i>)	
Score	Condition Description
1 - Poor	Animal extremely emaciated. Spinal vertebrae, ribs, tailhead, and point of hip and point of buttocks project prominently; bone structure of withers, shoulders, and neck easily noticeable; no fatty tissue can be felt.
2 - Very Thin	Animal emaciated. Slight fat covering over the base of spinal vertebrae; transverse processes of the lumbar vertebrae feel rounded; spinous processes, ribs, tailhead, and point of hip and point of buttocks prominent; withers, shoulders, and neck structures faintly discernible.
3 - Thin	Fat built up about halfway on the spinal vertebrae; transverse processes cannot be felt; slight fat cover over ribs; spinous processes and ribs easily discernible; tailhead prominent, but individual vertebrae cannot be identified visually; point of buttocks appear rounded but easily discernible; point of hip not distinguishable; withers, shoulders, and neck accentuated.
4 - Moderately Thin	Slight ridge along back; faint outline of ribs discernible; tailhead prominence depends on conformation, but fat can be felt around it; point of hip not discernible; withers, shoulders, and neck not obviously thin.
5 - Moderate	Back is flat (no crease or ridge); ribs not visually distinguishable but easily felt; fat around tailhead beginning to feel spongy; withers appear rounded over spinal vertebrae; shoulders and neck blend smoothly into body.
6 - Moderate to Fleshy	May be slight crease down back; fat over ribs spongy; fat around tailhead soft; fat beginning to be deposited along the side of withers, behind shoulders, and along the sides of neck.
7 - Fleshy	May have crease down back; individual ribs can be felt, but there is noticeable fat between ribs; fat around tailhead soft; fat deposited along withers, behind shoulders, and along neck.
8 - Fat	Crease down back; difficult to feel ribs; fat around tailhead very soft; area along withers filled with fat; area behind shoulder filled with fat; noticeable thickening of neck; fat deposited along inner thighs.
9 - Extremely Fat	Obvious crease down back; patchy fat appearing over ribs; bulging fat around tailhead, along withers, behind shoulders, and along neck; fat along inner thighs may cause them to rub together; flank filled with fat.

ENTRY REQUIREMENTS

1. Contestants may show **at any one area show per horse/rider combination.**
2. No post-entries will be accepted. No refunds will be granted for scratches received more than one week after the entry deadline with the exception that a partial refund (class entry fees only) may be made upon receipt of a doctor's or veterinarian's excuse. No refunds will be given for scratches received after 5pm on the Friday before the week of the State show. Areas refund rules may vary.
3. It is the responsibility of the 4-H'er, parents, leader, and county agent to check horse show entries to assure they are correctly filled out, especially the **names** and **numbers** of the classes entered. **No class may be added, and no class changes will be allowed.** (The exception will be to allow horses that do not fit within the required height limitations to be moved to the proper class.)

4. **A contestant may show up to two horses at area or state shows.** An exhibitor may enter two horses in the following classes: western trail, ranch riding, ranch trail, ranch reining, ranch roping, working cow horse (boxing only), keyhole, stake race, pole bending, barrel race, working hunter, handy hunter, training level dressage, first level dressage, and western dressage.
5. **The maximum number of classes an exhibitor/horse combination may enter is five.** One exhibitor/horse combination may enter only one Showmanship and one Ground Handling class.
6. A single horse (whether owned or leased) may be shown by a maximum of three 4-H members at the Area and State horse shows. In the case where a horse is shown by more than one 4-H member, the maximum number of classes a horse may enter is six. A horse is allowed to enter a single class only once, and only one conformation class.
7. Contestants must show the same horse(s) at the state show as they qualified on at the area show. An exhibitor/horse combination is considered an entry. Individual exhibitor/horse combinations will qualify independently for State and Regionals.
8. Stallions are not allowed to be shown at area and state shows. If numbers warrant, counties may provide a class for foals or colts to encourage breeding projects. Showing uncastrated males past December 31 of the year of his birth is prohibited.
9. All horses should be properly immunized under the supervision of a veterinarian before coming to a 4-H show. Vaccines should be administered far enough in advance for adequate immunity to be developed (approximately 30 or more days for most vaccines). Horses should be vaccinated against Equine Encephalomyelitis (Eastern, E.E.E. and Western, W.E.E.), tetanus, influenza, West Nile, and in some cases rhinopneumonitis. Equine Infectious Anemia (Coggins) test must be negative and current (within the past 12 months) at the time of the show. Proof of negative Coggins must be presented along with horse to personnel inspecting same before horse will be allowed to compete or possibly enter show grounds. **Horse's name on both Coggins papers and entry form, as well as registration papers if applicable, must be the same.** Proof of negative Coggins may be electronic, PDF, original paper, or photocopy.

QUALIFYING PROCEDURE AT AREA SHOWS FOR STATE

Number of qualifiers to progress from area to state show will be determined by State Extension Horse Specialist. Number to progress to state show from each area may vary from year to year. An exhibitor/horse combination must receive a minimum of 1 point at one of the three area shows to qualify for state in 2026. Hardship Exemption requests may be submitted to the State Extension Horse Specialist through your county agent for alternative qualifying criteria. Visit the state horse extension website under the 'horse shows' tab to download the request form.

AREA POINT SYSTEM

1. Each of the first six horses in a class will be given one point for each horse placing below it, plus one point. Points not to exceed six for first place.
2. Each area has the option of using a sliding scale to allow more points to be added for large classes.
3. Horses not placing in the top six in a class will not receive points for that class unless a sliding scale is used.

4. The number of horses in a class will be determined by the number actually shown.
5. Under no circumstances shall a disqualified contestant receive points; however, all horses brought into the ring will constitute an entry and will be counted.

STATE POINT SYSTEM

1. For classes with 25 or fewer contestants, each of the first ten horses placed in a class will be given one point for each horse placing below it, plus one point.

(Example: 1st place = 10 points, 2nd place = 9 points, etc.)

2. In classes with greater than 25 contestants the following scale applies:

26 to 35	1 additional point
36 to 45	2 additional points
46 to 55	3 additional points
56 to 65	4 additional points
66 to 75	5 additional points
76 to 85	6 additional points
86 and over	7 additional points

The additional points from the scale above are reflected in this quick-reference table.

Place	Number of Entries In Class																
	≥86	85-76	75-66	65-56	55-46	45-36	35-26	25-10	9	8	7	6	5	4	3	2	1
1	17	16	15	14	13	12	11	10	9	8	7	6	5	4	3	2	1
2	16	15	14	13	12	11	10	9	8	7	6	5	4	3	2	1	
3	15	14	13	12	11	10	9	8	7	6	5	4	3	2	1		
4	14	13	12	11	10	9	8	7	6	5	4	3	2	1			
5	13	12	11	10	9	8	7	6	5	4	3	2	1				
6	12	11	10	9	8	7	6	5	4	3	2	1					
7	11	10	9	8	7	6	5	4	3	2	1						
8	10	9	8	7	6	5	4	3	2	1							
9	9	8	7	6	5	4	3	2	1								
10	8	7	6	5	4	3	2	1									
11	7	6	5	4	3	2	1										
12	6	5	4	3	2	1											
13	5	4	3	2	1												
14	4	3	2	1													
15	3	2	1														
16	2	1															
17	1																

For example, a horse placing first in a class of 68 would receive 15 points. The tenth place horse would receive 6 points, and 15th place would receive 1 point. Up to ten horses will be placed regardless of number in class.

3. In the event of additional points awarded in a class, points will be awarded beyond 10th place to a sufficient number of horses so the last horse receiving points will receive one point.
4. The number of horses in a class will be determined by the number actually shown.

- Under no circumstances shall a disqualified contestant receive points; however, all horses brought into the ring will constitute an entry and be counted.

TIE BREAKING PROCEDURES

CLASS TIES: Ties for 1st, 2nd, and 3rd place in judged events will be worked off. Ties below 3rd place in judged events will be broken at the discretion of judge and show committee. Ties for all placings in timed events will be run off. In the event of a tie in a timed class, the contestant declared the winner in a runoff must run the pattern in not more than two seconds over the original time or the runoff must be held again. For ties not broken by judge or run off, any points involved will be evenly split between contestants.

HIGH POINT AWARDS:

For a horse/rider combination to be eligible for a division high point, they must show in a minimum of two (2) classes listed within that division. In a case of ties, the following priority order will be used:

- Most points earned in performance classes.
(Performance classes include all mounted classes and Showmanship and Ground Handling.)
- Most points earned in the greatest number of five possible classes.
(Ex. Rider A earns 43 points while placing in 4 classes, and Rider B earns 43 points while placing in 5 classes. Rider B wins the tie breaker for placing in more classes.)
- Total number of horses beaten in any one class.
(Ex. The most horses Rider X beat in one class was 42 in Hunter Under Saddle. The most horses Rider Y beat in one class was 39 in Hunt Seat Equitation. Rider X wins the tie breaker for beating more horses in one class.)
- The entry with the highest placings.
(Ex. Rider C had placings of 1st, 2nd, 2nd, and 5th. Rider D had placings of 1st, 2nd, 3rd, and 4th. When comparing their placings top to bottom, they each got a 1st, they each got a 2nd, but Rider C won another 2nd while Rider D won a 3rd. Therefore, Rider C wins the tiebreaker. The lower placings are not compared once the tie was broken with Rider C having a greater number of higher placings.)
- The entry with the higher placing in a Showmanship or Ground Handling class.

PLACING AWARD COLORS

The following colors will be used for class placing awards:

Area & State		State only:	
1 st	Blue	7 th	Purple
2 nd	Red	8 th	Brown
3 rd	Yellow	9 th	Grey
4 th	White	10 th	Light Blue
5 th	Pink		
6 th	Green		

CONTEST RULES, REGULATIONS, AND PROCEDURES

1. These rules and regulations contained herein take precedence over any other rules concerning conduct of the show and participation therein.
2. Show management reserves the right to alter or modify any class procedures, obstacles, patterns, or rules in this book for safety concerns, show facility restrictions, or other mitigating circumstances.
3. Show management reserves the right to refuse an exhibitor entry into any class or event if they deem that entry unsafe for the exhibitor and/or other exhibitors or animals. With the exhibitor's safety in mind, any activity or situation deemed unsafe can and will be stopped by show management and may result in disqualification from that class.
4. **The P.A. system is used to help the show move as smoothly as possible but is only a courtesy. It is the responsibility of the contestants to know when they are required to be in the make-up area or arena. Not hearing or understanding gate calls, etc. is NOT an excuse for missing one's order of work, heat, or class.**
5. The judge's decision shall be final and may not be protested.
6. All exhibitors are required to wear an SEI* or SEI/ASTM* approved safety equestrian helmet with fastened chin harness in all classes and all warm-up and make-up areas. Additionally, appropriate footwear and approved helmets must be worn, with harness fastened, at all times when mounted. This pertains to the entire show grounds from the time of arrival until departure. Failure to comply may result in disqualification. (SEI - Safety Equipment Institute, ASTM - American Society of Testing and Measures)

It is the responsibility of the exhibitor, or the parent or guardian or trainer of the exhibitor, to see to it that the headgear worn complies with appropriate safety standards for protective headgear intended for equestrians' use and is properly fitted and in good condition. The Florida 4-H Program and officials are not responsible for checking appropriateness of headgear worn.

The Florida 4-H Program and officials make no representation or warranty, expressed or implied, about any protective headgear, and cautions riders that death or serious injury may result despite wearing such headgear. Because all equestrian sports involve inherent risks, no helmet can protect against all foreseeable injuries.

7. Contestant numbers shall be worn on the exhibitor's back or attached to the saddle pad on both sides. It is the exhibitor's responsibility to ensure that the correct number is shown with the correct horse. Failure to comply will result in disqualification from said class.
8. An Appeals Committee shall be designated by the management before the show begins and is to be on the grounds for the duration of the show. This committee is to receive and act upon any protests arising out of any class or event. A protest must be filed in writing to show management personnel immediately upon conclusion of the class or event in question. The protest must be accompanied by a \$100 cash only fee. If the protest is upheld by the Appeals Committee, the deposit shall be refunded. If the protest is over-ruled, the deposit shall be forfeited to the horse show fund.

9. The show will be held on the date scheduled barring a natural catastrophe. It is the responsibility of the exhibitor's parent or guardian to determine if he/she is able to compete safely. In case of inclement weather, all contestants must realize that the conditions and facilities are the best available as determined by the show management and show accordingly.

Management reserves the right to stop or cancel a class in progress due to storm, accident, or other emergency (Ex: lightning storm). In the event of a class being stopped while in progress due to any of the above, the following procedure should be followed:

If it is a class in which horses compete together (i.e., pleasure class or heat), when the class or heat is resumed it shall be held in its entirety and no consideration shall be given to the performance during the original session. If it is restarted in a location substantially different, then the class may be rerun in its entirety with original qualifiers remaining qualified and additional qualifiers may be added.

If it is a class in which horses compete individually (i.e., horsemanship), when the class is resumed it shall be continued from the point stopped. Possible exception could be made if when resumed the class is held in a different location. Similarly, if the class is rescheduled to another day, it will be started from the beginning with no consideration given to the performance during the original session.

10. No horse or rider shall be assisted beyond the plane of the arena gate. Failure to comply will result in disqualification.
11. In support of the 4-H horse philosophy and to ensure maximum acceptance of responsibilities through learning experiences, only 4-H exhibitors registered at the current show are allowed to ride while on the show grounds. Lunging (in a halter with no other tack or equipment on the animal) by someone other than the exhibitor is permitted. Failure to comply may result in disqualification of the contestant.
12. Lunging is not permitted in warm up areas where a class is being staged.
13. When an exhibitor or another person on behalf of an exhibitor is guilty of unsportsmanlike conduct or misbehavior while on the show grounds, management may suspend such exhibitor's right to participate in future classes and/or shows as deemed appropriate.
14. Assistance or coaching of contestants while competing in a class may warrant penalties or disqualification. No electronic communication devices will be allowed by exhibitors while in the class.
15. An official of the show may check the appointments of any horse/rider combination throughout the duration of the show. It is the responsibility of the contestant to comply with all 4-H rules and regulations. The judge, at their discretion, may disqualify an exhibitor for inappropriate appointments or equipment.
16. In concern for humane treatment of the horse, the judge, at their discretion, has the authority to excuse any horse from a class which is obviously lame. Obvious lameness is: consistently observable at a trot under all circumstances; marked nodding, hitching, or shortened stride; minimal weight-bearing in motion and/or at rest, and inability to move.

17. The judge or designated show officials have the authority to require the removal or alteration of any piece of equipment which, in their opinion, is unsafe, tends to give unfair advantage, or is deemed inhumane. Inhumane treatment of a horse identified by the show committee at any time on the show grounds may result in disqualification, dismissal, and suspension from further participation in classes subject to approval of show, and/or appeals committee. Any horse receiving inhumane treatment while exhibiting may be dismissed upon the discretion of the judge or show official appointed by the show management committee. The standard by which conduct or treatment will be measured is that which the show management committee rules a reasonable person, informed and experienced in generally accepted equine training and exhibition procedures, would determine to be cruel, abusive, or inhumane in accordance with AQHA and USEF.
18. The use of fake tails is strongly discouraged. Loss of a fake tail during a class will result in disqualification from that class.
19. Striking a horse in front of the cinch with anything other than the open hand is a disqualification. Striking the horse with anything, including hand, in front of the throatlatch is a disqualification. See Hunter Division, page 69, for exceptions.
20. Chemical stimulants, depressants, and caustic agents are prohibited and can result in disqualification. All horses are subject to drug testing by the State of Florida Department of Agriculture whose rules will apply.
21. While performing in a class, if a horse steps one or more feet out of bounds or out of the arena, that entry is disqualified.
22. Fall to ground by horse or rider during competition and while being judged or timed will result in disqualification.
23. Upon dismissal by the judge or other show official, horse/rider must leave the arena immediately.
24. In scored classes, a zero (0) total score will not be placed.
25. Ponies will be required to be measured on the day of the show at time and place designated by the show committee. If they do not meet the height restrictions, they will be allowed to enter the proper class. If the animal has shoes and/or pads on, the thickness of these should be subtracted from the height of the animal.
26. The management of the show reserves the right to determine the number of horses that will be brought back to any semifinals, finals, or workout unless that number has been previously determined.
27. In all pleasure and pleasure-type classes (e.g., those classes where several horses are in the arena at the same time) the following statements apply:
 - A. Large numbers will necessitate elimination heats to accommodate all horses. The suggested maximum number is 15 horses per heat. Finalists in each heat must be brought to the center of the arena and identified.
 - B. Any portion of a class or heat may be placed on the rail for extra work by the judge at any time.

- C. At no time shall the fault-out system be used those results in a contestant being eliminated individually. Instead, a more positive approach should be used, with winners being announced and the remainder of the class being dismissed from the arena as a group. Individual horses will not be pulled off the rail while the class is being judged.
 - D. The specific number of finalists selected from each preliminary heat need not be the same and is left to the discretion of the judge.
28. In Showmanship, Ground Handling, Western Horsemanship, and Hunt Seat Equitation, individual patterns will be completed prior to line-up/rail work. See each class's rules for scoring system to be used. Judging emphasis will be on pattern work, execution, and demonstrated horsemanship/equitation. Ties or close scores may be broken on line-up/rail work. Additional pattern work may be requested in finals or semifinals. When more than one pattern is utilized, all scores are cumulative.
 29. For any judged class in which a pattern or course is utilized, the judge or show management shall post any pattern(s) to be worked at least one hour prior to the commencement of the class. If pattern books are distributed to contestants, whether as hard copy or electronic format, the responsibility of posting patterns has been met. If the judge requires additional work of exhibitors for consideration of final placing, the pattern will not be posted.
 30. An electric timer is preferred for timed events and will be used when available at area shows and at the state show. In the absence of an electric timer, the average time from at least two stop watches will constitute the official time. At state show only, when an electric timer is used all timed events will be backed up by at least 2 stop watches. In the event of a malfunction by the electric timer the contestant will be given the option of taking the average time of the stop watches or having a rerun. Contestant is not to know the time before making decision as to take time or rerun.
 31. No rerun will be given to any contestant if handicapped by failure of personal equipment or accident to horse or rider.
 32. No string, rubber bands, or other material to tie feet or legs in stirrups is allowed. The use of any material to affix rider to any part of the saddle is prohibited.
 33. Bandages (leg wraps) are not permitted in any class.
 34. It is not allowable for exhibitors to wear electronic devices, including but not limited to GoPro Camera, earpieces, cell phones, etc., during competition except for medical devices.

Bits

For examples, scroll to the link for "Bit Details" at: <http://go.ufl.edu/9wdkzqj>

Random bit checks may be conducted by the judge or show management.

Western, Ranch, and Speed Events Divisions

1. Reference to snaffle bits mean the conventional O-ring, egg-butt, or D-ring with ring no larger than 4". The mouthpiece should be round, oval, or egg-shaped, smooth and unwrapped metal. It may be inlaid but must be smooth. The mouthpiece may be two or three pieces. A three-piece connecting ring of 1¼" or less in diameter, or a connecting flat bar of 3/8" to 3/4" (measured top to bottom), which lies flat in the horse's mouth, or rollers are acceptable.
2. References to a bit mean the use of a curb bit that has a solid or broken mouthpiece, has shanks, and acts with leverage. All curb bits must be free of mechanical device and should be considered a standard western bit. A description of a legal, standard western bit includes:

A. 8½" maximum length shank to be measured as indicated in the diagram illustrating legal bit. Shanks may be fixed or loose.

B. Curb bit mouthpieces must be round, smooth, and unwrapped metal of 5/16" to 3/4" in diameter, measured one

inch in from the cheek. They may be inlaid but must be smooth. Nothing may protrude below the mouthpiece (bar), such as extensions or prongs on solid mouthpieces. The mouthpiece may be two or three pieces. A three-piece, connecting ring of 1¼" or less in diameter, or a connecting flat bar of 3/8" to 3/4" (measured top to bottom), which lies flat in the horse's mouth, or rollers are acceptable.

C. The port must be no higher than 3½" maximum, with rollers and covers acceptable. Broken mouthpieces, halfbreed, and spades are standard.

3. References to a romal means an extension of braided material attached to closed reins. This extension may be carried in the free hand with an approximate 16" spacing between the reining hand and the free hand holding the romal. The rider's hand shall be around the reins with the fingers closed, thumb on top, and no fingers between the reins.

4. The romal shall not be used forward of the cinch or to signal or cue the horse in any way. Any infraction of this rule shall be penalized severely by the judge.

5. A curb bit must be used with a curb strap or curb chain properly attached to make contact with horse's chin. Chain curb straps must be at least 1/2" in width and lie flat against the jaw of the horse. No wire curbs, regardless of how taped or padded. Absolutely no rigid material will be permitted under the jaws, regardless of how padded or covered.

Legal Bit

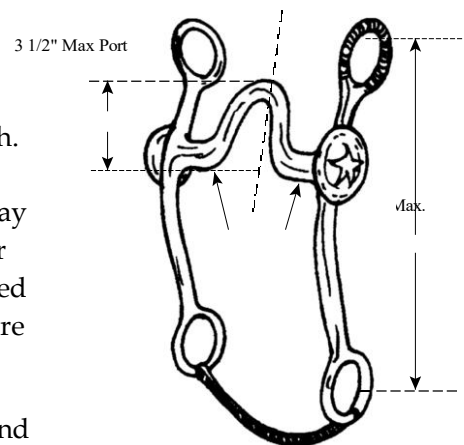

Some Illegal Bits

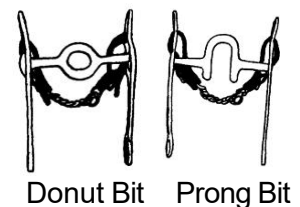

Some Acceptable Curb Straps



Western Division and Ranch Division (Western Dressage, see exceptions, pg. 28)

1. References to hackamore mean the use of a non-mechanical flexible, braided rawhide or leather, or rope bosal, the core of which may be either rawhide or flexible cable. (Exception: Paso Finos in the Ranch Division may use hackamore typical for their breed.) Absolutely no rigid material will be permitted under the jaws, regardless of how padded or covered.
2. Snaffle bit bars must be a minimum of 5/16" in diameter, measured one inch in from the cheek with a gradual decrease to center of the snaffle.
3. Slip or gag bits, and donut and flat polo mouthpieces are not acceptable.
4. Horses five-years-old and younger may be shown in a snaffle bit, hackamore, curb bit, half-breed, or spade bit.
 - A. When using a snaffle bit, a loose hobble strap is optional (leather or nylon only, no chain). Reins to be attached above the hobble strap, if used.
 - B. Leather or woven split reins or mecate reins are acceptable with a snaffle bit.
 - C. Junior horses (5 years old and under) that are shown with a hackamore or snaffle bit may be ridden with two hands on the reins. The rider's hands should be carried near the pommel and not further than 4" out on either side of the saddle horn. Rider's hands must be steady with very limited movement. Rider's hands should always be visible to the judge(s).
5. Horses six-years-old and older may only be shown in a curb bit, half-breed, or spade bit.
 - A. Only one hand may be used on the reins, and hand must not be changed. When using split reins, the hand is to be around the reins, and if desired only the index finger may be between the reins. Violation of this rule is an automatic disqualification.
 - B. In ranch classes when showing in a curb bit, reins must be held in one hand and may be held in any manner.

Speed Events Division Only

1. Mouthpieces must be between 1/4" to 3/4" in diameter, measured 1" from the cheek.
2. "Slow twist" mouthpieces are permitted, but "corkscrew" or "twisted wire" bits are illegal.



3. References to hackamore mean the use of either a mechanical or non-mechanical hackamore.
 - A. Non-mechanical: Flexible, braided rawhide or leather, or rope bosal, the core of which may be either rawhide or flexible cable.
 - B. Mechanical: The core may be any flexible cable, rawhide, or metal material, and must be covered with leather, soft plastic tubing, or similar material for padding. Lariat-rope type nose bands are acceptable without covering.
 - C. For either type of hackamore, absolutely no rigid material will be permitted over the nose or under the jaws, regardless of how padded or covered.
4. Slip or gag bits will be allowed provided the mouthpiece and shank requirements/limitations are met as described in the Western & Speed Events section. "Rutledge Roper" bits will also be allowed.
5. Horses of any age may be shown with a snaffle bit.
6. Riders may use two hands on the reins regardless of type of bit and age of horse.
7. Judge or appointed equipment official may prohibit the use of bits or equipment deemed too severe.

Hunter Division Bits

All Hunter classes except Dressage

1. An English snaffle (no shank), kimberwick, pelham, or full bridle (Weymouth) must be used. If a bit is used that requires two reins, it may not be used with a converter. Snaffle bit rings may be no larger than 4" in diameter.
2. In reference to mouthpieces, nothing may protrude below the mouthpiece (bar). Solid and broken mouthpieces must be between 5/16" to 3/4" in diameter, measured 1" from the cheek and may have a port no higher than 1½".
 - A. Smooth round, oval or egg-shaped, and straight bar or solid mouthpieces are allowed. They may be smooth inlaid, synthetic wrapped (including rubber or plastic), or encased. Waterford bits are allowed. Snaffle bits with slow twist, corkscrew, or single twisted wire mouthpieces are allowed.
 - B. On broken mouthpieces, connecting rings of 1¼" or less in diameter or connecting flat bar of 3/8" to 3/4" (measured top to bottom) which lie flat in the horse's mouth, or rollers are acceptable.
3. Any bit having a fixed rein requires use of a curb chain. Curb chain must be at least 1/2" wide and lie flat against the jaw of the horse.
4. Double-twisted wire, triangle (knife edge), true gag action, and elevator bits are not allowed.

Dressage Bits

Only snaffle (non-leverage) bits are permitted, and they must be smooth with a solid surface. The rein and cheekpiece attach to the same ring and can rotate freely around that ring (exception: hanging cheek snaffles).

1. A snaffle bit may be a combination of any mouthpiece and any cheekpiece pictured. Keepers are permitted for full cheek, half cheek, and Fulmer snaffles (pictured bits #5, 6 and 7).
2. The mouthpiece of a snaffle bit must be made of metal, flexible rubber, or synthetic material. A metal mouthpiece may have a covering of rubber or plastic (in manufactured state), but the bit cannot be modified by adding latex or other material. Leather or leather covered bits are prohibited. The contours of the bit must conform to those of the bits pictured.
3. The diameter of the snaffle mouthpiece must be minimum 3/8-inch diameter where it meets the rings or cheeks. Twisted bits, bits with "bumps," bits with uncovered wire or cable, and bits that place mechanical restraint upon the tongue are prohibited. Joints that could trap or pinch the oral tissues are not permitted.
4. A snaffle bit may be unjointed, single-jointed, or double-jointed. The center link in a double-jointed snaffle must be smooth and curved on all surfaces as in a lozenge-shaped link. It may not have the effect of a tongue plate. Dr. Bristol and French link bits are not allowed. The center joint or link may be tilted in a different orientation from the mouthpiece and may have a bushing, barrel, coupling, or ball joints. The surface of the center piece must be solid or have only one rolling part in the center of the mouthpiece, as pictured.

5. The mouthpiece of a jointed or unjointed snaffle may be shaped to allow tongue relief. The maximum height of the deviation (port) is 1¼ inch from the lowest part of tongue side to the highest part of the deviation. The widest part of the deviation must be where the mouthpiece contacts the tongue and must have a minimum width of 1 inch. Ported snaffles that do not meet these specifications are prohibited.

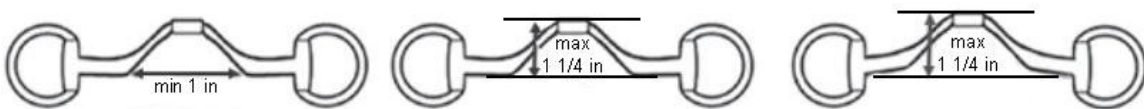
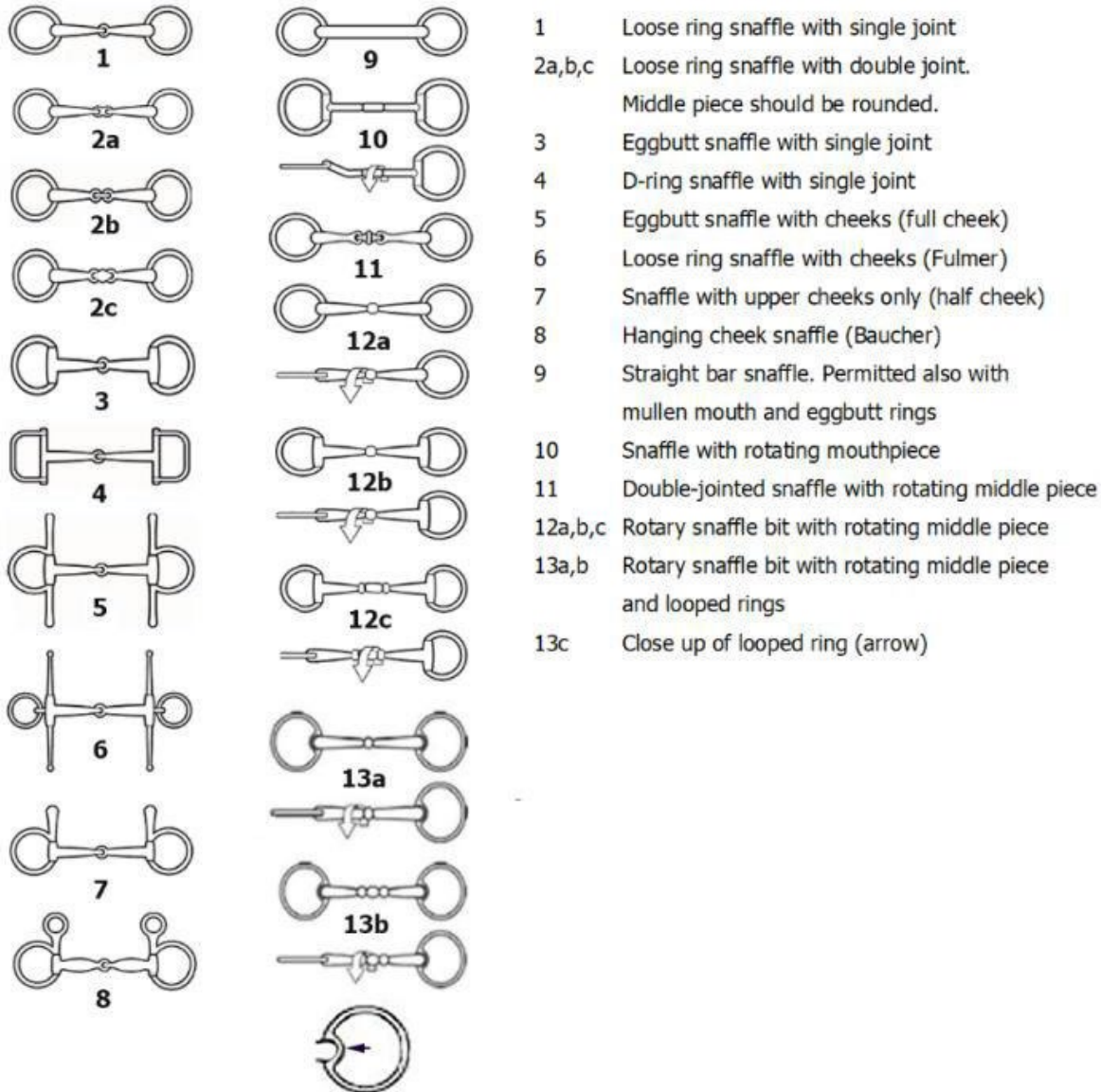

CLASSES

CONFORMATION CLASSES (Classes 1–3, 34–36)

1. Personal appearance of the club member: neat, clean, well groomed, attentive, courteous, and in appropriate attire as described in each division. An SEI or SEI/ASTM approved equestrian helmet with fastened chin harness is required in all divisions.
2. Horses judged on conformation, condition, heritable defects, soundness, and way of going at discretion of judge.
3. Horses should enter the appropriate conformation class for their body type – Stock Type or Hunter Type. A horse may enter only one conformation class.
4. Horses will be judged individually while standing, at a walk, and a trot on the line.
5. Horses may be shown in halters made of leather, rope, or other suitable material. In English classes horse may be shown in halter or bridle.
6. Lead shank/bridle reins must be carried in both hands at all times and the lead shank/bridle reins must not be wrapped around the right hand. It is acceptable to either figure-8 or loose coil the excess lead shank/bridle reins in the left hand.
7. When showing with halter and lead with a chain, the chain may be under the horse's chin, or passed through the bottom, center ring of the halter and folded back on itself. No chain may be in the horse's mouth or over the nose.
8. Whips, crops, or bats of any type are not permitted in conformation classes.
9. During a class, horses will be handled and shown by one club member only.
10. Horses should enter the ring as specified by the official. Subsequent procedures will be as directed by judge and/or ring steward.
11. When the top 10 horses are placed (top 6 for areas), ring steward shall line them up in order of placing so that the public may see how the horses are placed.

SHOWMANSHIP and GROUND HANDLING CLASSES

(Classes 4–5, 13–14, 24–25, 37–38)

1. Showmanship and Ground Handling classes are not conformation, model, or grooming classes, although grooming and fitting is certainly part of the judging criteria. These are performance classes designed to test the exhibitor's horsemanship while working from the ground.
2. Showmanship is the appropriate class for the Western and Hunter Divisions, while Ground Handling is the appropriate class for the Ranch and Speed Events Divisions.

To be eligible to compete in a division's Showmanship or Ground Handling class, horse/rider entry must show in one other performance (riding) class in that division unless only showing in in-hand classes.

3. Club member and equipment:
 - A. Personal appearance of the club member: neat, clean, well groomed, attentive, courteous, and in appropriate attire as described in each division. An SEI or SEI/ASTM approved equestrian helmet with fastened chin harness is required in all divisions.

B. Equipment is to be clean and properly adjusted:

- (1) Hunter: Hunter bridle or halter.
- (2) Western: Halters only. Fancy halters shall not be given preference over good working halters.
- (3) Ranch and Speed Events: Halters only. Halters and leads may be rope, nylon, or plain leather (no silver). Lead ropes may not have chain. **Nose bands may not be made of rawhide or be inflexible (like a bosal).** Please reference the two illegal halter/nosebands to the right.
- (4) Lead shank/bridle reins must be carried in both hands at all times and the lead shank/bridle reins must not be wrapped around either hand. It is acceptable to either figure-8 or loose coil the excess lead shank/bridle reins in the left hand.
- (5) When showing with halter and lead with a chain, the chain may be under the horse's chin, or passed through the bottom, center ring of the halter and folded back on itself. No chain may be in the horse's mouth or over the nose.
- (6) No whips, crops, or bats are permitted.



4. Horse (fitting and grooming):

- A. Animal care is of top priority for the Florida 4-H horse program and will be evaluated in these classes via body condition score and soundness check. Any animal severely under or overweight will be penalized. Horses that are severely lame will be disqualified. These rules will be enforced at the judge's discretion and only in extreme circumstances.

- B. The horse should be clean, well groomed, and fitted for its type.
 - C. The horse's feet should be cleaned and either trimmed or properly shod.
5. Method of showing:
- A. Walk, trot (or natural gait¹) turn, stop, back, and pose your horse as directed by the judge or ring steward.
 - B. Lead from the left side of your horse, unless otherwise instructed. When showing your horse, travel by his side – never directly in front. His head should be about even with your shoulder. When moving, keep your horse's neck, head, and body in a straight line and maintain precise control.
 - C. Show the horse with a shank short enough to assure maximum control and responsiveness from the horse. The basic position of the exhibitor should allow constant observation of the horse's feet and also permit observation of the judge and ring officials.
 - D. Never obstruct the view of the judge and do not stand directly in front of the horse.
 - E. Run by the left side of your horse when you are showing him at the trot (or natural gait¹). He should move willingly toward or away from the judge with his head, neck, and body in a straight line. He should trot freely, fast and be alert with head up but not too high.
 - F. When a particular show ring procedure being used by a judge requires horses to be reversed, they should be turned to the right. Turn in as small a space as possible and attempt to keep the horse's hind feet planted in one place while turning.
 - G. Keep your horse posed at all times and know where the judge is and what he/she wants. A good showman always gives the judge the best view of the horse. You cannot change your horse's type and conformation, but you can improve his style and appearance. Make it easy for the judge to see your horse to its best advantage.
 - H. Keep your proper position in line and allow reasonable space (at least six feet) between your horse and the other horses. Never let your horse interfere with another horse.
 - I. Be alert when leading in a circle – observe the horse in front of you; bumping this horse from the rear is a serious fault in showmanship and very unsafe.
 - J. If asked to change positions in the line, back your horse out of the line and approach the new position from behind. Space horses adequately.
 - K. Move easily, quietly, and with confidence when showing your horse. Be courteous, respond promptly to directions, and demonstrate good horsemanship at all times.

¹ Gaited horses in Ground Handling

6. Class Procedures:

A. Each exhibitor will individually perform a given pattern which will be composed from the following optional list of tests. The judge will score each exhibitor on his/her individual skills and execution of the pattern. Optional list of tests for exhibitors which may be executed collectively or individually follows (Junior division entrants may be tested using 1-8 and 12-14; Senior division entrants may be tested using 1-18):

(1) Square horse for inspection:

-Showmanship: Judge may walk completely around horse as exhibitor demonstrates the quarters system.

-Ground Handling: Judge will only walk in front of the horse.

(2) Walk a straight line or walk a curve*, either direction

(3) Trot (or natural gait in GH) a straight line

(4) Trot (or natural gait in GH) a curve*, either direction

(5) Pivots, moving the forehand:

-Showmanship: up to 360°

-Ground handling: up to 270°

(6) Stop

(7) Back straight

(8) Answer questions from the judge

(9) SR only – Back a curve*

(10) SR only – Extension of walk or trot (or natural gait in GH).

(11) SR only – Western Showmanship only: pivots up to 540° (1½ turns)

*Curve = any non-straight line including, but not limited to: any change of direction from gradual turns to distinct turns, circles or portions of circles, or multiple curves to create a shape.

Additional Maneuvers for Ground Handling Only:

(12) Step away from the horse to the end of the lead while horse remains still

(13) Lower the horse's head (pulling down on the lead or pressure on the poll)

(14) Move the hindquarters, up to 90° (turn on forehand)

(15) SR only – Move the hindquarters, up to 270° (turn on forehand)

(16) SR only – Demonstrate a sidepass

(17) SR only – Back the horse while handler remains stationary

(18) SR only – Send horse in a circle (either direction), around a marker, or over a pole.

B. Finalists will be required to return to the arena. Individual patterns will be completed prior to work in a line-up. Additional pattern work may be requested in finals. Placing of ties or close scores may be adjusted on line-up work as appropriate. *When more than one pattern is used, all scores are cumulative.

C. Ground Handling Only: Exhibitors may be asked to work from both the left and right side of the horse during any of the listed maneuvers (switching hands on the lead is permitted). Exhibitors may touch the horse to initiate any lateral movement and when asked to lower the horse's head. The judge will recognize added degree of difficulty of not touching the horse and this will be reflected in the maneuver score.

D. Ground Handling Only: Poles, barrels, and cones may be used as markers to define maneuver locations/parameters. However, the pattern should not take on the appearance of an "In-hand Trail" class. Hitting/touching/moving these objects will not be scored as penalties but taken into account when scoring the handler's abilities.

Showmanship Scoring System – Western and Hunter

1. Showmanship is designed to evaluate the exhibitor's ability to execute, in concert with a well-groomed and conditioned horse, a set of maneuvers prescribed by the judge with precision and smoothness while exhibiting poise and confidence, and maintaining a balanced, functional, and fundamentally correct body position. The exhibitor's overall poise, confidence, appearance and position throughout the class, and the physical appearance of the horse will be evaluated.
2. Scoring will be on the basis of 0-infinity, with 70 denoting an average performance. Patterns will be divided into 6-10 maneuvers, and each maneuver will be scored from +3 to -3, with ½ point increments acceptable that will be added or subtracted from 70: +3 excellent, +2 very good, +1 good, 0 average/correct, -1 poor, -2 very poor, -3 extremely poor. Maneuver scores are to be determined independently of penalties and should reflect equal consideration of both performance of the exhibitor's pattern and the form and effectiveness of the exhibitor and presentation of horse. Exhibitors overall form and effectiveness should also be scored from 0 to 5 with 0 to 2 Average, 3 Good, 4 Very Good, 5 Excellent

Penalties should be assessed per occurrence as follows:

A. Three (3) points

- (1) Break of gait at the walk or trot up to 2 strides
- (2) Over or under turning up to 1/8 of a turn
- (3) Ticking or hitting cone
- (4) Sliding a pivot foot
- (5) Lifting a pivot foot during a pivot or set-up and replacing it in the same place
- (6) Lifting a foot in a set-up and replacing it in the same place after presentation

B. Five (5) points

- (1) Not performing the specific gait or not stopping within 10 feet of designated location
- (2) Break of gait at walk or trot for more than 2 strides
- (3) Splitting the cone (cone between the horse and exhibitor)
- (4) Horse stepping out of or moving the hind end significantly during a pivot or turn
- (5) Horse stepping out of set-up after presentation
- (6) Horse resting a foot or hipshot in a set-up
- (7) Over or under turning 1/8 to 1/4 turn

C. Ten (10) points

- (1) Exhibitor is not in the required position during inspection
- (2) Exhibitor touching the horse or kicking or pointing their feet at the horse's feet during the set-up
- (3) Standing directly in front of the horse
- (4) Loss of lead shank, holding chain or two hands on shank
- (5) Blatant disobedience including biting, kicking, rearing, or pawing; horse continually circling exhibitor

D. Disqualifications (should not be placed) including:

- (1) Loss of control of horse that endangers exhibitor, other horses, or judge

- (2) Horse becomes separated from exhibitor
- (3) Failure to display correct number
- (4) Willful abuse
- (5) Excessive schooling or training; use of artificial aids
- (6) Illegal equipment
- (7) Off pattern, including knocking over or wrong side of cone or marker; never performing designated gait; over or under turning more than 1/4 turn

Ground Handling Scoring System – Ranch and Speed Events

1. This class tests the handler's ability to communicate with the horse from the ground by judging a series of maneuvers that require the horse to yield to pressure – forward, backward, and laterally. Maneuvers are selected to be realistic in their application to everyday training. Exhibitor movements should be workmanlike and efficient, and the horse should be obedient and cooperative. Evaluating safe and effective ground handling will take priority to the quality of attire or tack.
2. Each exhibitor will perform a pattern that will consist of no less than seven (7) of the maneuvers listed in the class procedures section. Exhibitors may be asked to work from both the left and right side of the horse during any of the listed maneuvers (switching hands on the lead is permitted).
3. Penalty points and/or certain maneuvers will be designated as tie breakers and shall be selected prior to the beginning of the class.
4. Scoring will be on the basis of 0 to 100 with 70 denoting an average performance. Judges will assess each maneuver on a scale from +3 to -3, with ½ point increments acceptable that will be added or subtracted from 70: +3 excellent, +2 very good, +1 good, 0 average/correct, -1 poor, -2 very poor, -3 extremely poor. In addition to the maneuver score, exhibitors can incur penalty points as listed below.
5. Penalties
 - A. One-half (½) point
 - (1) Break of gait (walk or trot/natural gait) up to 1 full stride
 - B. One (1) point
 - (1) Touching horse other than when allowed. It is acceptable to touch the horse to sidepass, move the hindquarters, and lower the head.
 - (2) Horse moving one (1) step during any portion when it should be standing still
 - C. Two (2) points
 - (1) Freeze up: complete loss of forward, backward, or lateral movement within a maneuver
 - (2) Break of gait (walk or trot) for more than 1 full stride
 - (3) Horse moving more than one (1) step during any portion when it should be standing still.
 - (4) Stepping out of obstacle or over any unintended pole (or other obstacle marker) with one foot, accruing with each additional step.
 - (5) Use of hand on halter in any manner
 - (6) Touching horse with lead (first offense)

- (7) Incorrect or incomplete answer to the judge's question
- (8) Artificial or overdone showing

D. Five (5) points

- (1) Inappropriate Body condition score: Clearly below a 4 or clearly above a 7
- (2) Balking, continued spooking, kicking, biting, rearing, striking
- (3) Failure to complete a maneuver
- (4) Touching horse with end of lead (second offense)

E. Zero (0) score

- (1) Off pattern
- (2) Consistent Lameness
- (3) Illegal attire
- (4) Illegal tack
- (5) Abuse

WESTERN DIVISION (Classes 1–12)

APPOINTMENTS:

PERSONAL: Clothing must be clean and neat. Riders shall wear western boots (no tennis shoes or sport shoes are acceptable) and western dress pants or jeans. Shirts must have a collar and long sleeves or be appropriate show attire (i.e., slinkies, band collars, turtlenecks). Spurs, chaps, and similar equipment are optional. All exhibitors are required to wear an SEI or SEI/ASTM approved equestrian safety helmet with fastened chin harness in every class (see rule #6 on page 7).

TACK: Horse shall be shown with a stock saddle; silver equipment will not count over a good working outfit. Martingales, tie-downs, nose bands, or draw reins are prohibited. Carrying of a rope is optional. A judge or show official shall have the authority to require the removal or adjustment of any piece of equipment which in their opinion is unsafe, would give a horse an unfair advantage, or constitute excessive harshness or cruelty. **See Bits section (pg. 11-12) for description of legal bits for Western Division. Refer to Western Dressage (pg. 28) for exceptions and/or for additional requirements.**

WESTERN PLEASURE, Classes 6–8

1. Horses to be shown at a walk, jog, and lope on a reasonably loose rein or light contact without undue restraint.
 - A. Horses must work both ways of the ring at all three gaits to demonstrate their ability with different leads. At the option of the judge, horses may be asked to extend the walk, jog, or lope, one or both ways of the ring. The judge may ask all or just the finalists to extend at the jog; however, never more than 10 horses at a time may be asked to extend at the lope. Riders should sit at the extended jog. Horses are required to back easily and stand quietly.

- B. Horses are to be reversed to the inside (away from the rail). They may be required to reverse at the walk or jog at the discretion of the judge but shall not be asked to reverse at the lope.
 - C. Judge may ask additional work of the same nature from any horse. He is not to ask for work other than that listed above.
 - D. Rider shall not be required to dismount except in the event judge wishes to check equipment.
2. The judge may ask that only finalists be backed.
 3. This class will be judged on the performance of the horse at the discretion of the judge.
 4. Reins shall be held in one hand and cannot be changed during the performance, unless a horse or pony, five years of age or younger, is being shown in either a snaffle bit or bosal. If showing with one hand on the reins, the free hand shall not be used to support the rider by being placed on any part of the saddle.
 5. Contestants must use split reins or romal – roping reins are not permitted. Only one finger between reins is permissible.
 6. A good pleasure horse has a free-flowing stride of reasonable length in keeping with his conformation. He should cover a reasonable amount of ground with little effort. Ideally, he should have a balanced, flowing motion. He should carry his head and neck in a relaxed, natural position, with his poll level with or slightly above the level of the withers. He should not carry his head behind the vertical, giving the appearance of intimidation, or be excessively nosed out, giving a resistant appearance. His head should be level with his nose slightly in front of the vertical, having a bright expression with his ears alert. He should be shown on a reasonably loose rein, but still have light contact and control. He should be responsive, yet smooth, in transitions when called for. When asked to extend, he should move out with the same flowing motion. Maximum credit should be given to the flowing balanced and willing horse which gives the appearance of being fit and a pleasure to ride.
 7. An exhibitor/horse combination may NOT enter both Western Pleasure and Ranch Rail at the same show.

WESTERN HORSEMANSHIP, Classes 9–10

1. General:
 - A. Riders will be judged on basic position in saddle; position and use of hands, legs, and feet; ability to control and show horse; and suitability of horse to rider.
 - B. Scores on individual work will be based on rider's skills and execution of the pattern.
2. Seat, Position of Hands, Legs, and Feet:
 - A. Basic position: Sit erect, seat deep in the saddle with your body balanced and relaxed. There should be a straight line from the point of the shoulder, through the hip to the heel. The leg should maintain light contact with the horse's body through the inside thigh and upper half of the calf. The foot should be straight ahead or toed out slightly in a natural position with weight on the ball of the foot and the heel lower than the toe.

- B. Arms and Hands: Arms and hands should be held in an easy, relaxed manner. Upper arms are held in a straight line with the body, the one holding the reins bent at the elbow. Only one hand is to be used for reining, and hands shall not be changed on reins. Hand is to be around reins, with one finger permitted between split reins. Both hands may be used on the reins if showing a horse or pony, five years of age or younger, in either a snaffle bit or bosal. Reins are to be carried immediately above, to slightly in front of, saddle horn. Reins should be gathered so that light contact in the horse's mouth is maintained. Free arm should be bent at the elbow and held close to, but not touching, the body.
3. Position in Motion:
- A. The rider's body should be in rhythm and balance with the action of the horse, helping the horse move easily, but never interfering by being behind the action. The rider's seat will shift at the various gaits, so the body is placed in balance with the action of the horse.
- B. Walk: The rider's body is to remain balanced and flexes at the waist with the movement.
- C. Jog/trot: The trot is ridden western style (no posting) with rider's body deep in the saddle, but with enough weight on the ankles to absorb the motion.
- D. Lope: The rider sits deep in the saddle. The hands should be relaxed to allow for rhythm with the movement of the horse's head. The legs should be in close contact with the saddle and horse.
4. Class Routine:
- A. Each rider will individually perform a given pattern which may be composed of 6 to 10 maneuvers from the following optional list of tests. Optional list of tests for exhibitors which may be executed collectively or individually follows (Junior division riders may be tested using 1 through 13; Senior division riders may be tested using 1 through 15):
- (1) Perform gaits in straight lines, curves, circles, or any combination to create additional shapes.
 - (2) Stop.
 - (3) Back straight, in an "L" or circle.
 - (4) 360 degree turn or spin.
 - (5) Pivot, both ways.
 - (6) Turns of varying degrees: 90, 180, 270, 360, etc.
 - (7) Rollbacks.
 - (8) Lope circles of varying size and speed.
 - (9) Pickup leads from standstill, walk, or trot.
 - (10) Simple lead changes in a circle.
 - (11) Simple lead changes on a straight away.
 - (12) Side pass.
 - (13) Extended gaits.
 - (14) *SR only* – Flying lead changes.
 - (15) *SR only* – Counter canter.
- B. The individual work scores will be used to determine the top riders who may be asked to work individually or on the rail.
- C. Finalists will be required to work on the rail at each gait in at least one direction.

5. Individual patterns will be completed prior to rail work. Placing of ties or close scores may be adjusted on rail work as appropriate. Additional pattern work may be requested in finals.
*When more than one pattern is utilized, all scores are cumulative.
6. Scoring will be on the basis of 0-infinity, with 70 denoting an average performance. Each maneuver will be scored from plus +3 to -3, with ½ point increments acceptable that will be added or subtracted from 70: +3 excellent, +2 very good, +1 good, 0 average/correct, -1 poor, -2 very poor, -3 extremely poor. Maneuver scores are to be determined independently of penalties and should reflect equal consideration of both performance of the exhibitor's pattern and the horsemanship form and effectiveness of the exhibitor. Exhibitor's overall horsemanship form and effectiveness should also be scored from 0 to 5 with 0 to 2 Average, 3 Good, 4 Very Good, 5 Excellent.

Penalties should be assessed per occurrence as follows:

A. Three (3) points

- (1) Break of gait at the walk or jog up to 2 strides
- (2) Over or under turn from 1/8 to 1/4 turn
- (3) Tick or hit of cone

B. Five (5) points

- (1) Not performing the specific gait or not stopping within 10 feet (3 meters) of designated location
- (2) Incorrect lead or break of gait at the lope (except when correcting an incorrect lead)
- (3) Break of gait at walk or jog for more than 2 strides
- (4) Loss of stirrup
- (5) Bottom of boot not touching pad of stirrup at all gaits including backup
- (6) Obviously looking down to check leads
- (7) Head carried too low and/or clearly behind the vertical while the horse is in motion, showing the appearance of intimidation

C. Ten (10) points

- (1) Loss of rein
- (2) Use of either hand to instill fear or praise while on pattern or during rail work
- (3) Holding saddle with either hand
- (4) Cueing with the end of the romal
- (5) Blatant disobedience including kicking, pawing, bucking, and rearing
- (6) Spurring in front of the cinch

D. Disqualifications (0 score – should not be placed):

- (1) Failure to display correct number
- (2) Abuse of horse or schooling
- (3) Fall by horse or exhibitor
- (4) Illegal equipment or illegal use of hands on reins
- (5) Use of prohibited equipment
- (6) Off pattern, including knocking over or wrong side of cone or marker; never performing designated gait or lead; over or under turning more than 1/4 turn.

WESTERN TRAIL, Classes 11-12

APPOINTMENTS: Tack and attire will be as described in the Western Appointments section (pg. 21).

1. This class will be judged on the performance of the horse over obstacles, with emphasis on manners, response to the rider and quality of movement. Credit will be given to horses negotiating the obstacles with style and some degree of speed, providing correctness is not sacrificed. Horses should receive credit for showing attentiveness to the obstacles and the capability of picking their own way through the course when obstacles warrant it, and willingly responding to the rider's cues on more difficult obstacles.
2. The judge(s) must walk the course and has the right and duty to alter the course in any manner. The judge may remove or change any obstacle he deems unsafe or non-negotiable prior to the start of the class. If at any time a trail obstacle is deemed to be unsafe by the judge, it shall be repaired or removed from the course. If it cannot be repaired and horses have completed the course, the score for that obstacle shall be deducted from all previous works for that class.
3. Horses shall be penalized for any unnecessary delay while approaching or negotiating the obstacles. Horses with artificial appearance over obstacles should be penalized.
4. Horses must not be required to work on the rail. The course must be designed, however, to require each horse to show the three gaits (walk, jog/natural gait, lope) somewhere between obstacles as a part of its work, and quality of movement and cadence should be considered as part of the maneuver score. While on the line of travel between obstacles, the horse shall be balanced, carrying his head and neck in a relaxed, natural position, with the poll level with or slightly above the withers. The head should not be carried behind the vertical, giving the appearance of intimidation, or be excessively nosed out, giving a resistant appearance. Gait between obstacles shall be at the discretion of the judge.
5. A committee of one to four individuals selected by the show management will score each horse as it goes through the course. Certain obstacles will be designated as tie breakers and shall be selected prior to the beginning of the competition.
6. Scoring will be on the basis of 0-infinity, with 70 denoting an average performance. Each obstacle will receive an obstacle score that should be added or subtracted from 70 and is subject to a penalty that should be subtracted. Each obstacle will be scored on the following basis, ranging from plus 1 ½ to minus 1 ½: -1 ½ extremely poor, -1 very poor, -½ poor, 0 correct, +½ good, +1 very good, +1 ½ excellent. Obstacle scores are to be determined and assessed independently of penalty points. Penalties should be assessed per occurrence as follows:
 - A. One-half (½) Point
 - (1) Each tick of log, pole, cone, plant, or any component of the obstacle.
 - B. One (1) Point
 - (1) Each bite of or hit of or stepping on a log, cone, plant, or any component of the obstacle.
 - (2) Incorrect or break of gait at walk or jog for two strides or less.
 - (3) Both front or both hind feet in a single-strided slot or space at a walk or jog.
 - (4) Skipping over or failing to step into required space.

- (5) Split pole in lope-over.
- (6) Incorrect number of strides, if specified.

C. Three (3) Point

- (1) Incorrect or break of gait at walk or jog for more than 2 strides.
- (2) Out of lead or break of gait at lope (except when correcting an incorrect lead).
- (3) Knocking down an elevated pole, cone, barrel, plant, or severely disturbing an obstacle.
- (4) Falling or jumping off or out of a bridge or a water box with one foot once the horse has gotten onto or into that obstacle
- (5) Stepping outside of the confines of an obstacle with designated boundaries (i.e., back through, 360 degree box, side pass) with one foot once the horse has entered the obstacle.
- (6) Missing or evading a pole that is a part of a series of an obstacle with one foot.

D. Five (5) Point

- (1) Dropping slicker or object required to be carried on course.
- (2) First or second cumulative refusal, balk, or evading an obstacle by shying or backing.
- (3) Letting go of gate or dropping rope gate.
- (4) Use of either hand to instill fear or praise.
- (5) Falling or jumping off or out of a bridge or a water box with more than one foot once the horse has gotten onto or into that obstacle
- (6) Stepping outside of the confines of an obstacle with designated boundaries (i.e., back through, 360 degree box, side pass) with more than one foot once the horse has entered the obstacle.
- (7) Missing or evading a pole that is a part of a series of an obstacle with more than one foot.
- (8) Blatant disobedience (including kicking out, bucking, rearing, striking).
- (9) Holding saddle with either hand.

E. Disqualified 0 – Score

- (1) Third cumulative refusal, balk, or evading an obstacle by shying or backing.
- (2) Use of two hands (except for junior horses shown with hackamore or snaffle bit) or changing hands on reins. Except for junior horses shown with hackamore or snaffle bit, only one hand may be used on the reins, but it is permissible to change hands to work an obstacle or straighten reins when stopped.
- (3) Use of romal other than as allowed in Contest Rules, Regulations, and Procedures.
- (4) Performing the obstacle or an essential element of the pattern incorrectly or other than in specified order.
- (5) No attempt to perform an obstacle or failure to complete an obstacle.
- (6) Equipment failure that delays completion of pattern.
- (7) Excessively or repeatedly touching the horse on the neck to lower the head.
- (8) Entering or exiting an obstacle from the incorrect side or direction.
- (9) Working obstacle the incorrect direction; including overturns of more than ¼ turn.
- (10) Riding outside designated boundary marker of the arena or course area.
- (11) Failure to ever demonstrate correct lead and/or gait between obstacles as designated.
- (12) Failure to follow the correct line of travel between obstacles.
- (13) Excessive schooling, pulling, turning, stepping, or backing anywhere on course.
- (14) Failure to open & shut gate; failure to complete gate.

- F. Faults scored according to severity which occur on the line of travel between obstacles include:
- (1) Head carried too high.
 - (2) Head carried too low and/or clearly behind the vertical excessively and consistently while the horse is in motion, or otherwise showing the appearance of intimidation.
 - (3) Opening mouth excessively.
7. Six to fifteen obstacles will be used. One of which will be mandatory, and 5 to 14 others selected from the optional list. The use of PVC for obstacles is allowed but discouraged. Horses may be asked to walk, jog/natural gait, and lope between obstacles. The gait between obstacles will be at the discretion of the trail committee (the course will be posted) and failure to follow designated gait between obstacles will result in penalty.
- A. Mandatory obstacle:
Opening, passing through and closing gate. (Use a gate which will not endanger horse or rider.)
- B. Optional obstacles (suggested - not limited to):
- (1) Ride over at least four logs.
 - (2) Ride over wooden bridge.
 - (3) Water hazard (ditch, shallow pond or simulated, etc.).
 - (4) Carry or drag object from part of arena to another. (Only objects which reasonably might be carried on a trail ride may be used.)
 - (5) Back horse through designated obstacles or patterns.
 - (6) Put on and remove slicker or simulate use of.
 - (7) Square box (maximum 6') to do 360 degree turn.
 - (8) Side pass.
 - (9) Mailbox.
 - (10) Any other safe and negotiable obstacle which could reasonably be expected to be encountered on a trail ride and meets the approval of the judge may be used.
- C. When setting up obstacles in the trail class, it should be kept in mind that ponies do enter this class. Obstacles which require a horse to go over them, such as jump or side pass obstacles, should be kept low enough that ponies can clear them.
- D. If disrupted, the course shall be reset. In the case that an obstacle is used in combination, the obstacle cannot be reset until the contestant finishes the entire combination.
8. Use of hands: Only one hand may be used on reins and hands must not be changed, except to work with an obstacle. Hand must be around reins. One finger between reins is permitted except with romal. Two hands may be used when using a snaffle bit or bosal on a horse 5 years old or younger.
9. While horse is in motion, rider's hands will be clear of horse and saddle.
10. Spurs or riding crop will not be used forward of the cinch.
11. Class Procedure: The trail course will be closed until the start of the class (no practice on the obstacles). There will be an order of go or a period in which the trail course will be open, which will be posted and announced. It will be the responsibility of the exhibitor to arrange to work the trail course during this open period or in the assigned order.

RANCH DIVISION (Classes 13–23)

APPOINTMENTS:

Hoof polish, braided or banded manes, tail extensions, and trimming inside ears are strongly discouraged.

PERSONAL: Clothing must be clean and neat. Riders shall wear western boots (no tennis shoes or sport shoes are acceptable) and western dress pants or jeans. Shirts must have a collar and long sleeves or be appropriate show attire. Ranch work attire is recommended but show attire will not be penalized. Spurs, chaps, gloves (leather or fabric) and similar equipment are optional. All exhibitors are required to wear an SEI or SEI/ASTM approved equestrian safety helmet with fastened chin harness in every class (see rule #6 on page 7).

TACK: Horse shall be shown with a stock saddle. Ranch work equipment is recommended but show equipment will not be penalized. **Roping reins are only permitted in Ranch Roping (Class 20).** Romal reins are permitted in this division. Martingales, tie-downs, nose bands, or draw reins are prohibited. Carrying of a rope on your saddle is preferred. Horses may wear protective boots only in Ranch Reining and Working Cow Horse. A judge or show official shall have the authority to require the removal or adjustment of any piece of equipment which in their opinion is unsafe, would give a horse an unfair advantage, or constitute excessive harshness or cruelty. **See Bits section (pg. 11-12) for description of legal bits for Ranch Division.** When showing in a curb bit, reins must be held in one hand but may be held in any manner.

RANCH RIDING, Classes 15–16

1. Ranch Riding serves to measure the ability of the horse to be functional and a pleasure to ride at a working speed while being used as a means of conveyance from one western stock horse task to another. The horse's performance should simulate a horse riding outside the confines of an arena and that of a working ranch horse. This horse should be well-broke, relaxed, quiet, soft, and cadenced at all gaits. The horse should be responsive to the rider, yield to contact, and make all required transitions smoothly, timely and correctly. The horse should perform with reasonable speed, and be obedient, well-mannered, free, and easy moving.
2. Class consists of pattern work which is ridden individually. For each maneuver, the horse is judged on quality of gaits, response to the rider, manners, and disposition. Maneuvers may include:
 - A. Walk, trot, and lope both directions. (All mentions of "trot" include "or natural gait")
 - B. Extended trot and extended lope at least one direction.
 - C. Stop and back from any gait.
 - D. Side pass.
 - E. Turns on the hindquarters of up to 2½ turns.
 - F. Turns on the forehand of up to 180°.
 - G. Change of lead (simple or flying).
 - H. Walk, trot, or lope over a pole(s).
 - I. Walk through, near, or around a pen of live cattle.
 - J. Work hard gate.

3. A horse will be given credit for traveling with his head held in a normal position, ears alert and moving at a natural speed for the gait requested. The horse should be ridden on a relatively loose rein with light contact and without requiring undue restraint. Excessively long floppy reins will be penalized.
4. All transitions should be smooth without undue exaggeration or resistance from the horse.
5. Use of hands: Only one hand may be used on reins and hands must not be changed. Reins may be held in any manner. Two hands may be used when using a snaffle bit or bosal on a horse or pony 5 years of age or younger.
6. The judge or show management will select which Ranch Riding pattern will be used. The class may be conducted inside or outside of an arena.
7. Penalty points and/or certain maneuvers will be designated as tie breakers and shall be selected prior to the beginning of the competition.
8. Description of Ideal Gaits – The ideal ranch riding horse will have a natural head carriage at each gait – neither too high nor too low.
 - A. Walk – The walk should be straight, square, flat footed, relaxed with the horse moving out freely and looking ahead.
 - B. Trot – This gait should be a square two-beat diagonal trot. The trot should be steady, soft, and slow enough for riding long distances. Trots which are rough and hard to sit should be penalized. Excessively slow and uncadenced trots should also be penalized.
 - C. Extended Trot – The extended trot should show an evident lengthening of stride from the regular trot with the same cadence that will cause an increase in speed. This trot should be level, flat and steady with the appearance that the horse could hold this gait for an extended distance.
 - D. Natural Gait and Extended Natural Gait – Non-trotting horses should perform their natural gait where a jog/trot is indicated and show a distinctive difference in speed of that gait where an extended jog/trot is asked. The natural gait should be smooth and appear effortless for riding long distances.
 - E. Lope – This gait should be a three-beat gait that is cadenced, straight and steady and is comfortable to ride over long distances
 - F. Extended Lope – The extended lope should be an obvious lengthening of stride from the previous lope, be at the same cadence and cause an increase in speed. The gait needs to be steady, quiet, and maintaining the increased speed while being under control.
 - G. Stop (from both lope and trot) – The horse should be in the correct stopping position – both hocks engaged and stopping on the hindquarters.
 - H. Reverse and Turns – A horse should turn briskly and flat with front feet close to the ground and holding an inside rear pivot foot.

- I. Turn on the forehand – Hind end should move around with minimal movement of the front feet.
 - J. Sidepass – a smooth, fluid sideways movement with a clean cross-over in front and behind.
 - K. Sitting the regular trot and lope is recommended; though standing in the stirrups at the extended trot and extended lope, or posting the extended trot, is acceptable.
9. Scoring will be on the basis of 0 to 100, with 70 denoting an average performance. The individual maneuvers are scored in ½ point increments from a low of -1½ to a high of +1½ with a score of 0 denoting a maneuver that is correct with no degree of difficulty. Natural ranch horse appearance will also be evaluated ranging from plus 1½ to minus 1½.
- A. One (1) point penalties:
 - (1) Too slow (per gait)
 - (2) Over-Bridled (per maneuver)
 - (3) Out of Frame (per maneuver)
 - (4) Break of gait at walk or jog for 2 strides or less
 - (5) Wrong lead or out of lead for 2 strides or less
 - B. Three (3) point penalties
 - (1) Break of gait at walk or jog for more than 2 strides
 - (2) Break of gait at lope, except when correcting an incorrect lead
 - (3) Wrong lead or out of lead for more than 2 strides
 - (4) Draped reins (per maneuver)
 - (5) Out of lead or cross-cantering more than two strides when changing leads
 - (6) Trotting more than three strides when making a simple lead change
 - (7) Trotting for more than 3 strides in lope departures or when exiting a rollback
 - (8) Severe disturbance of any obstacle
 - C. Five (5) point penalties
 - (1) Blatant disobedience (kick, bite, buck, rear, etc.)
 - D. Placed below horses performing all maneuvers (OP, off-pattern)
 - (1) Eliminates or adds maneuver
 - (2) Repeated blatant disobedience
 - (3) Incomplete maneuver
 - (4) Use of two hands (except in snaffle bit or hackamore)
 - E. Zero (0) score
 - (1) Illegal equipment
 - (2) Willful abuse

Note for all Ranch Riding Patterns:

Show management may choose to provide start/stop cones and/or cones marking perimeter boundaries.

The drawn description of these patterns is only intended for the general depiction of the pattern. Exhibitors should utilize the arena space to best exhibit their horses.

RANCH RIDING PATTERN #1

\\	Lead Change
.....	Walk
- - - -	Trot
- - - -	Ext Trot
————	Lope
————	Ext Lope
//////	Back

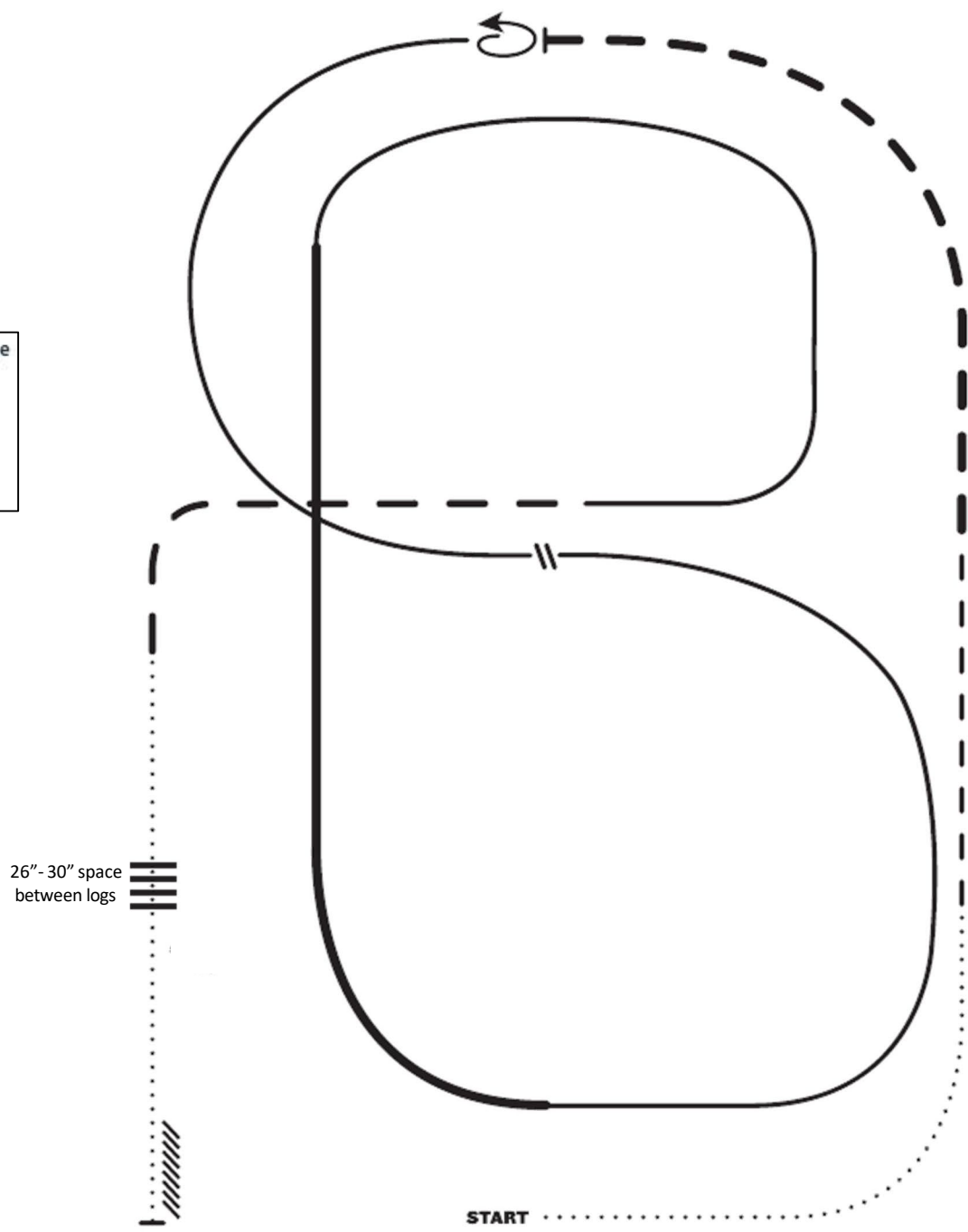

1. Walk
2. Trot
3. Extend the trot, at the top of the arena, stop
4. 360° turn to the left
5. Left lead ½ circle, lope to the center
6. Change leads (simple or flying)
7. Right lead ½ circle
8. Extended lope up the long side of the arena (right lead)
9. Collect back to a lope around the top of the arena and back to center
10. Break down to an extended trot
11. Walk over logs
12. Stop and back

RANCH RIDING PATTERN #2

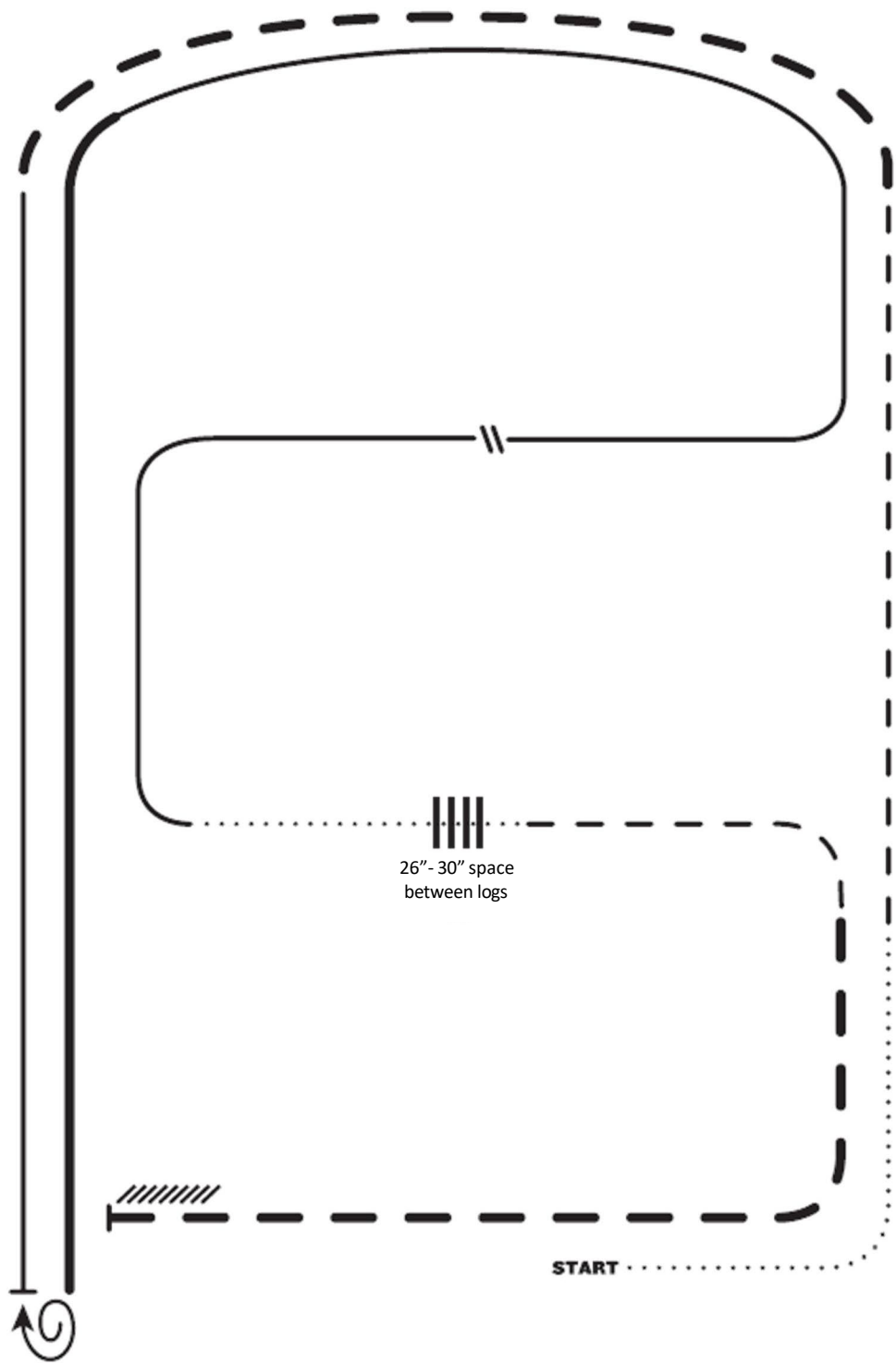
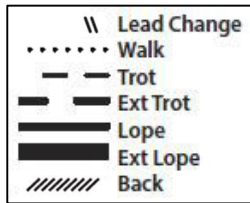

1. Walk
2. Trot
3. Extended trot
4. Left lead lope
5. Stop, 1 ½ turn right
6. Extended lope
7. Collect lope right lead
8. Change leads (simple or flying), continue lope left lead
9. Walk
10. Walk over logs
11. Trot
12. Extended trot
13. Stop and back

RANCH RIDING PATTERN #3

\\	Lead Change
.....	Walk
- - - -	Trot
- - - -	Ext Trot
————	Lope
————	Ext Lope
//////	Back

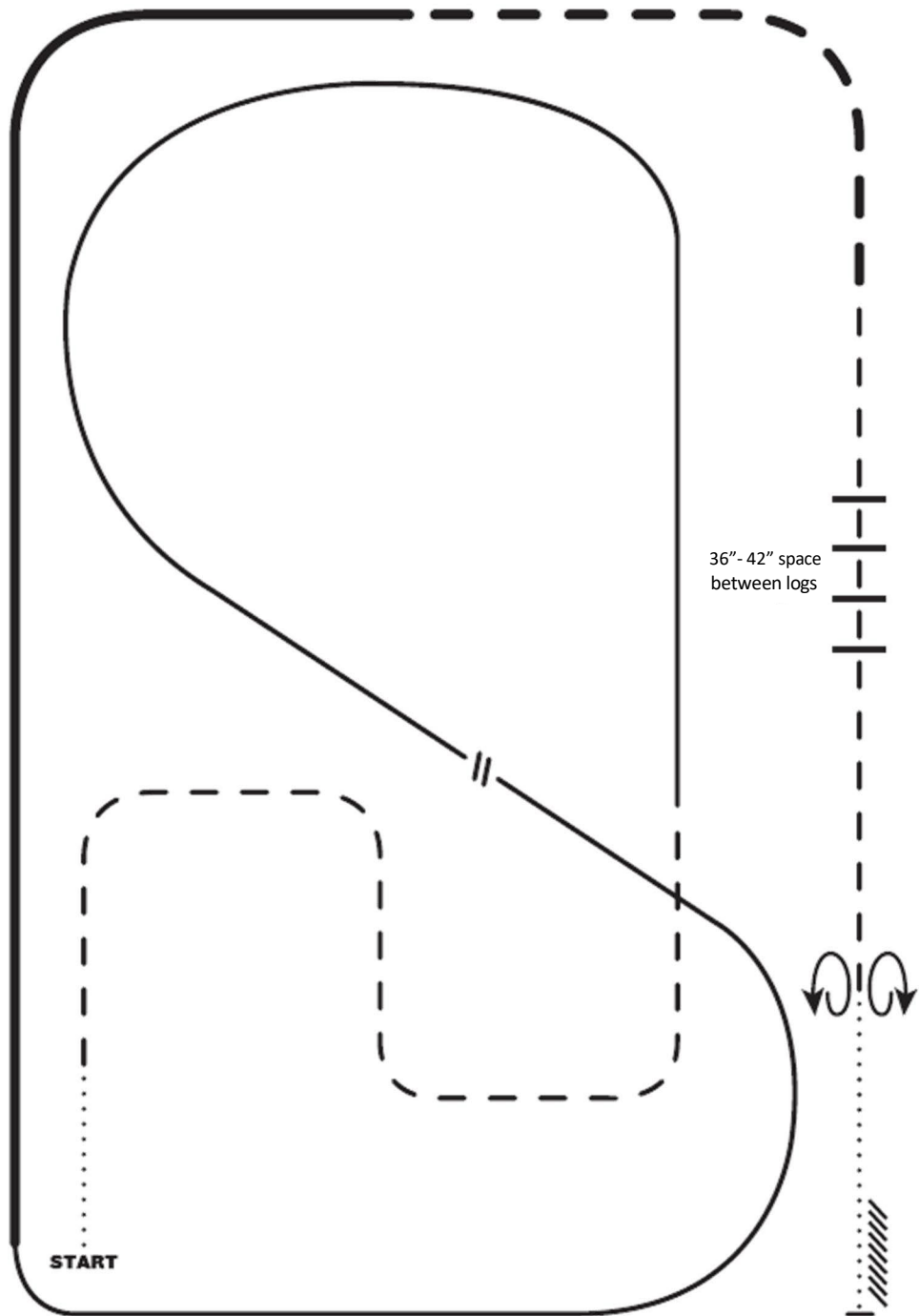

1. Walk
2. Trot serpentine
3. Lope left lead around the end of the arena and then diagonally across the arena
4. Change leads (simple or flying)
5. Lope on the right lead around end of the arena
6. Extend lope on the straight away and around corner to the center of the arena
7. Extend trot around corner of the arena
8. Collect to a trot
9. Trot over logs
10. Stop, 360° turn each direction (either direction 1st) (L-R or R-L)
11. Walk, stop and back

RANCH RIDING PATTERN #4

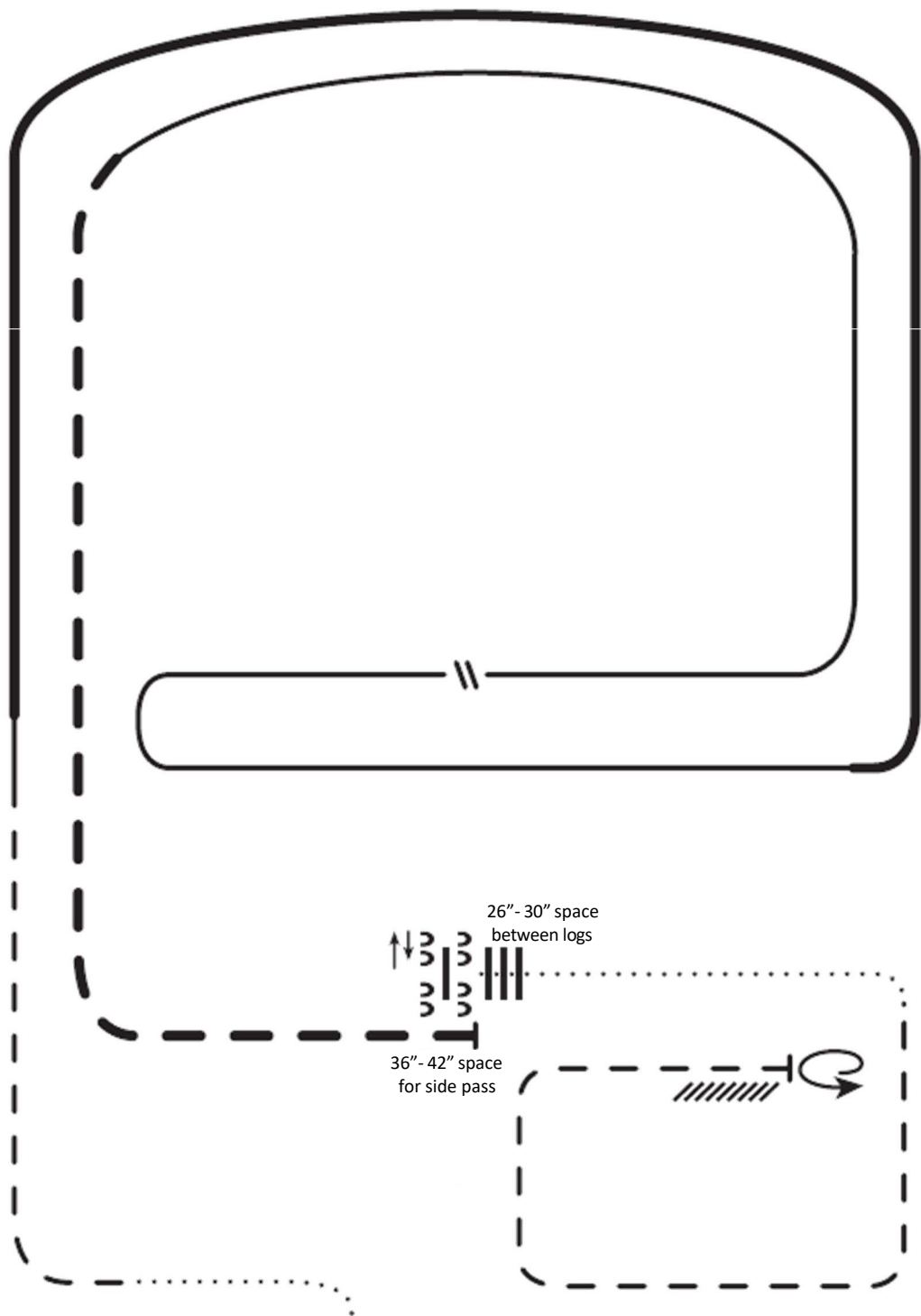
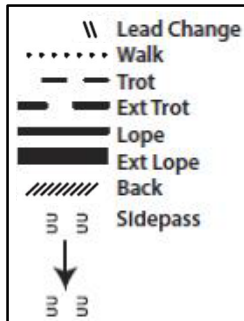

1. Walk
2. Trot
3. Extended lope right lead
4. Lope right lead
5. Change leads (simple or flying)
6. Lope left lead
7. Extended trot
8. Stop, side pass left, side pass right, 1/2 way
9. Walk over logs
10. Walk
11. Trot square
12. Stop, 360° turn left, back

RANCH RIDING PATTERN #5

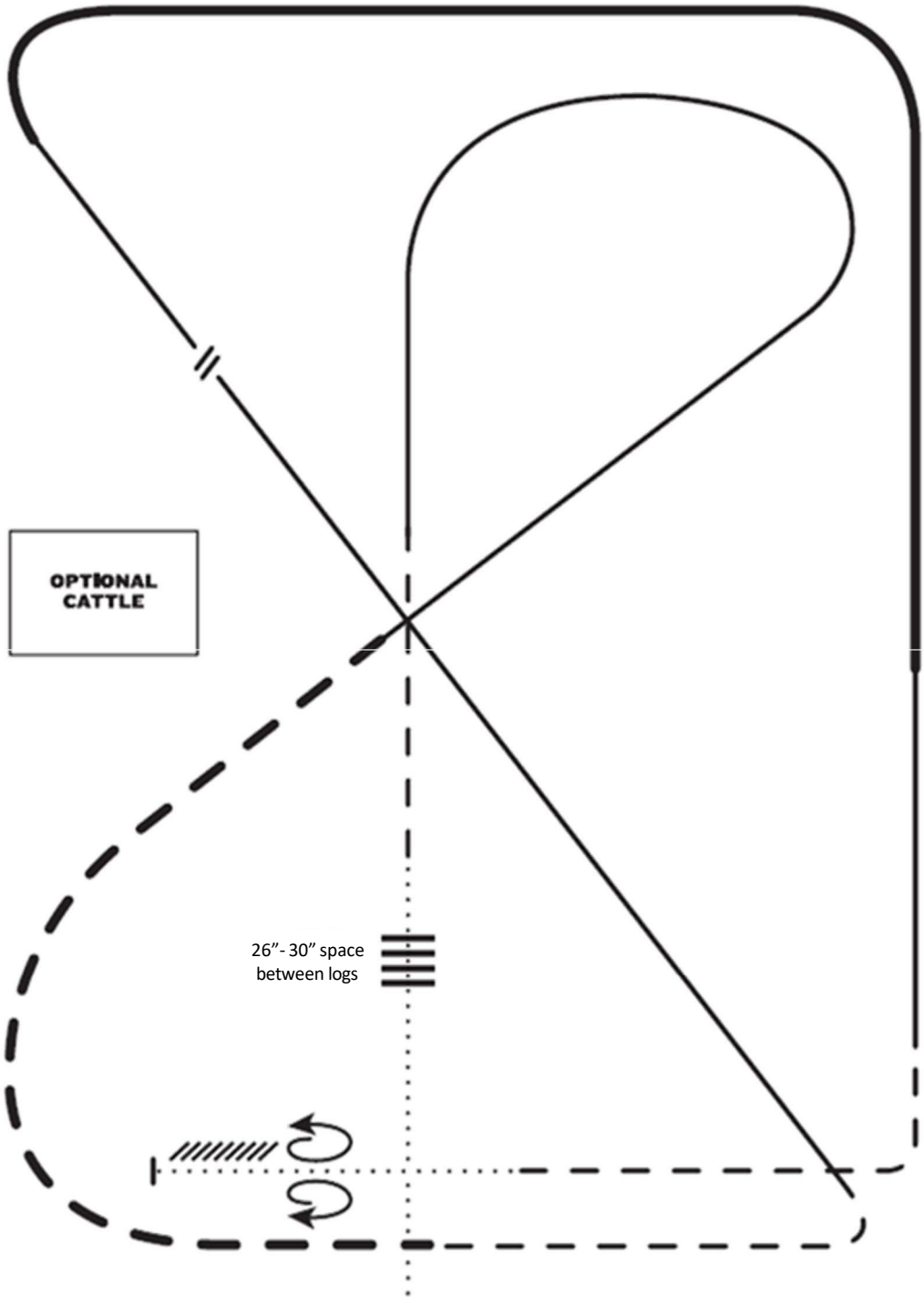
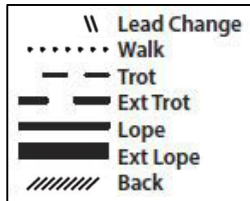

- | | |
|------------------------------------|---|
| 1. Walk | 9. Extended lope right lead |
| 2. Walk over logs | 10. Collect Lope |
| 3. Trot | 11. Trot |
| 4. Lope right lead | 12. Walk |
| 5. Extended trot | 13. Stop and back |
| 6. Trot | 14. 360° turn each direction (either direction 1st) |
| 7. Lope left lead | (L-R or R-L) |
| 8. Change leads (simple or flying) | |

RANCH RIDING PATTERN #7

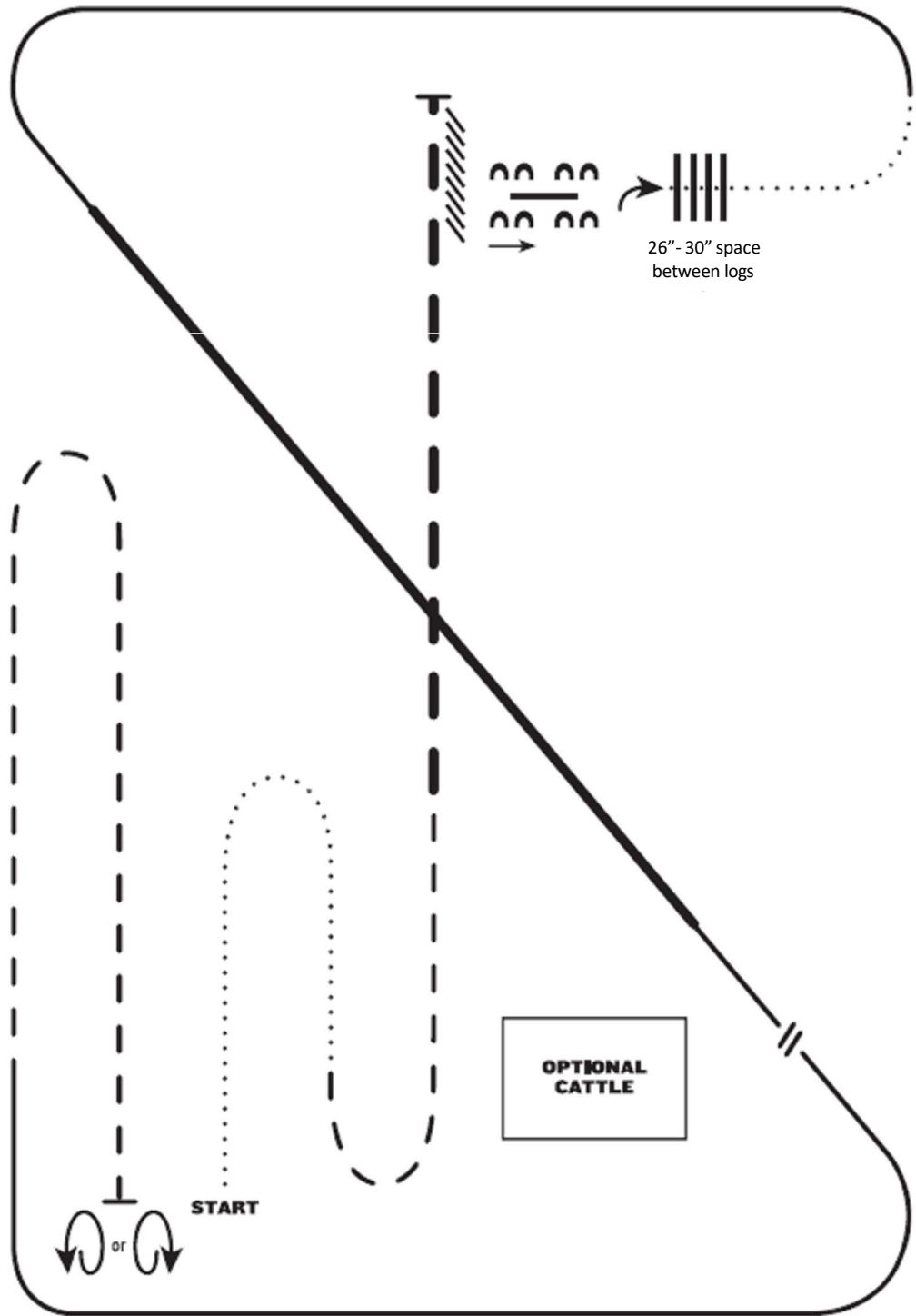
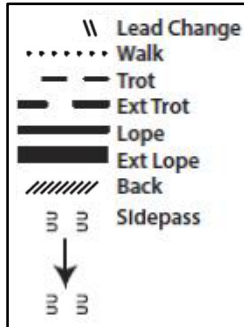

1. Walk
2. Trot
3. Extended trot
4. Stop and back
5. Side pass over log right
6. ¼ turn right, walk over logs
7. Walk
8. Lope left lead
9. Extended lope left lead
10. Collect lope, change leads (simple or flying)
11. Lope right lead
12. Trot
13. Stop, one 360° turn either direction

RANCH RIDING PATTERN #8

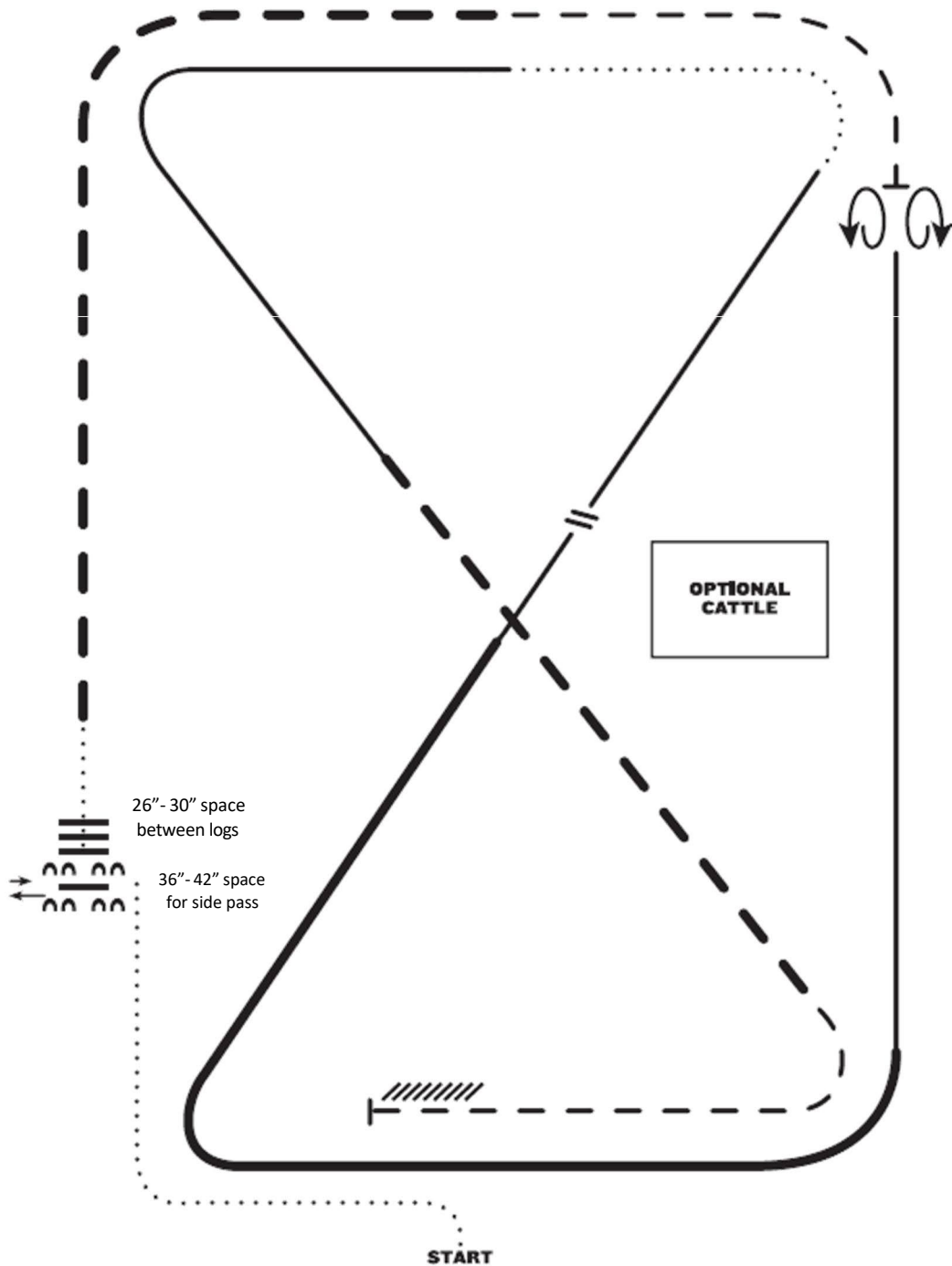
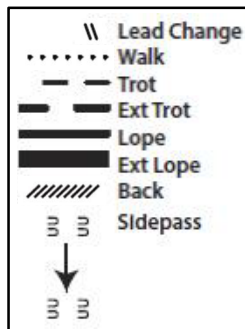

1. Walk
2. Side pass left across first log, side pass 1/2 way to right
3. Walk over logs
4. Extended trot
5. Trot
6. Stop, 360° turn each direction (either direction 1st) (L-R or R-L)
7. Lope right lead
8. Extended lope right lead
9. Collect lope, change leads (simple or flying), continue lope left lead
10. Walk
11. Lope left lead
12. Extended trot
13. Trot
14. Stop and back

RANCH RIDING PATTERN #9

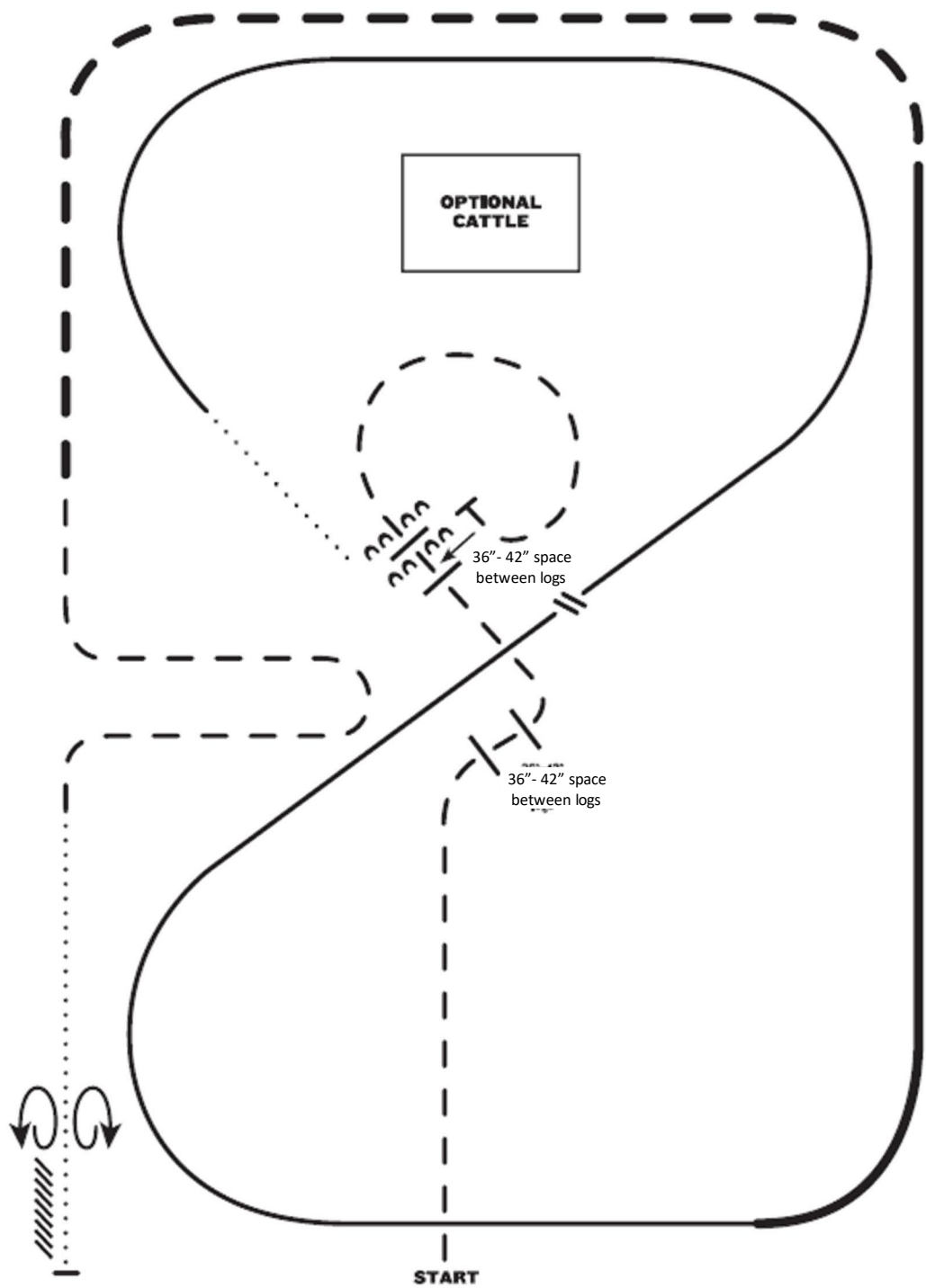
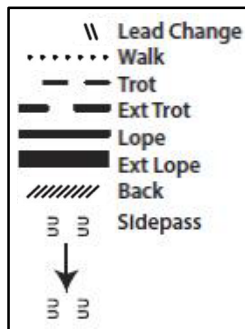

- | | |
|--|--|
| 1. Trot | 8. Extended lope left lead |
| 2. Trot over two sets of logs | 9. Extended trot |
| 3. Trot circle, stop and side pass log left over log | 10. Trot |
| 4. Walk | 11. Walk |
| 5. Lope right lead | 12. Stop and back |
| 6. Change leads (simple or flying) | 13. 360° turn each direction
(either direction 1 st) (L-R or R-L) |
| 7. Lope left lead | |

**RANCH RIDING
PATTERN #10**

**OPTIONAL
CATTLE**

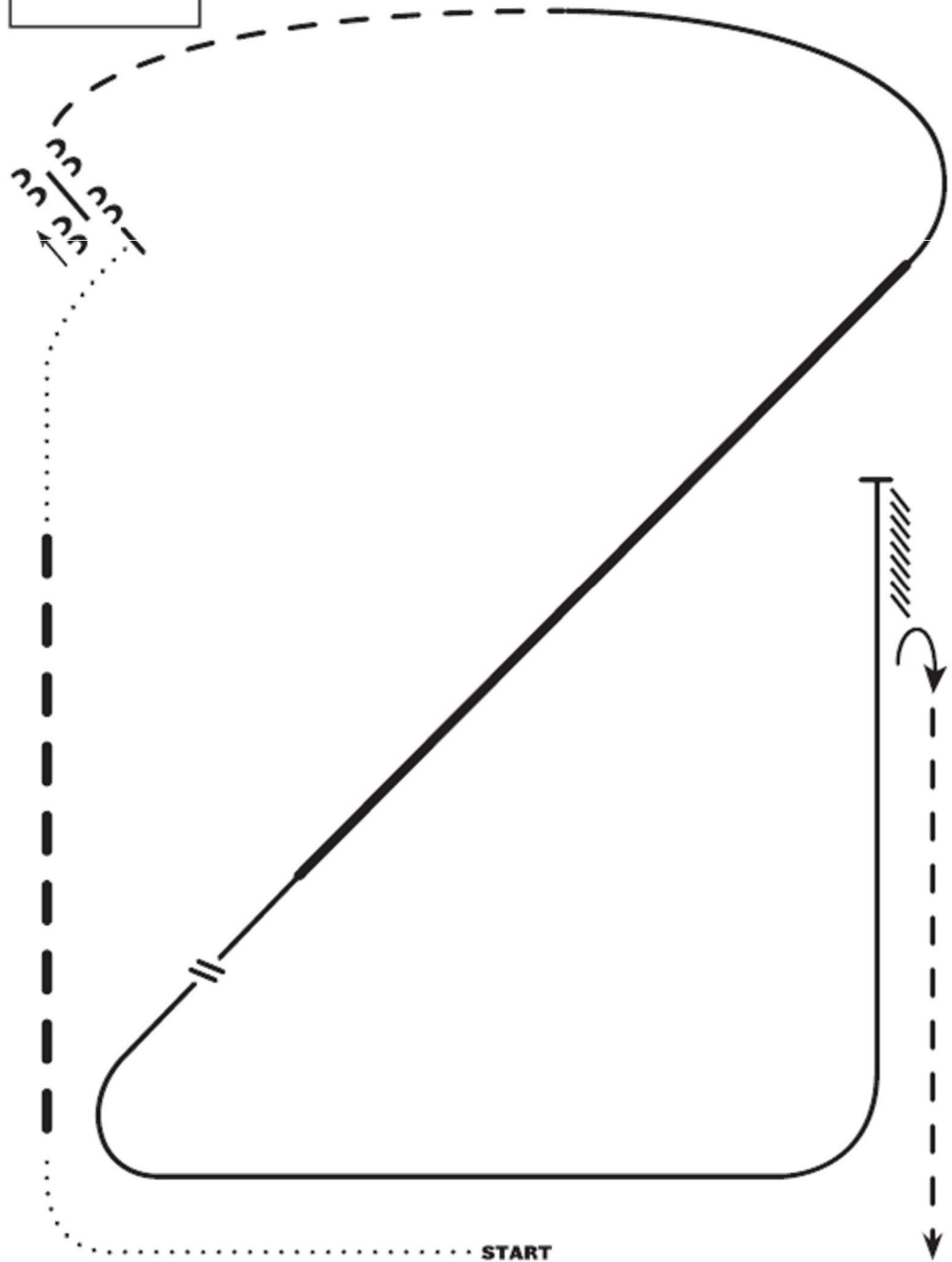
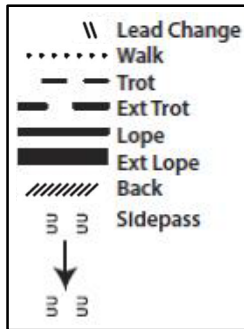

1. Walk
2. Extended trot
3. Walk
4. Stop, side pass left over log
5. Trot
6. Lope right lead
7. Extended Lope right lead
8. Collect lope and change leads (simple or flying)
9. Lope left lead
10. Stop and back
11. 1/2 turn to right
12. Trot (to exit)

RANCH RIDING PATTERN #11

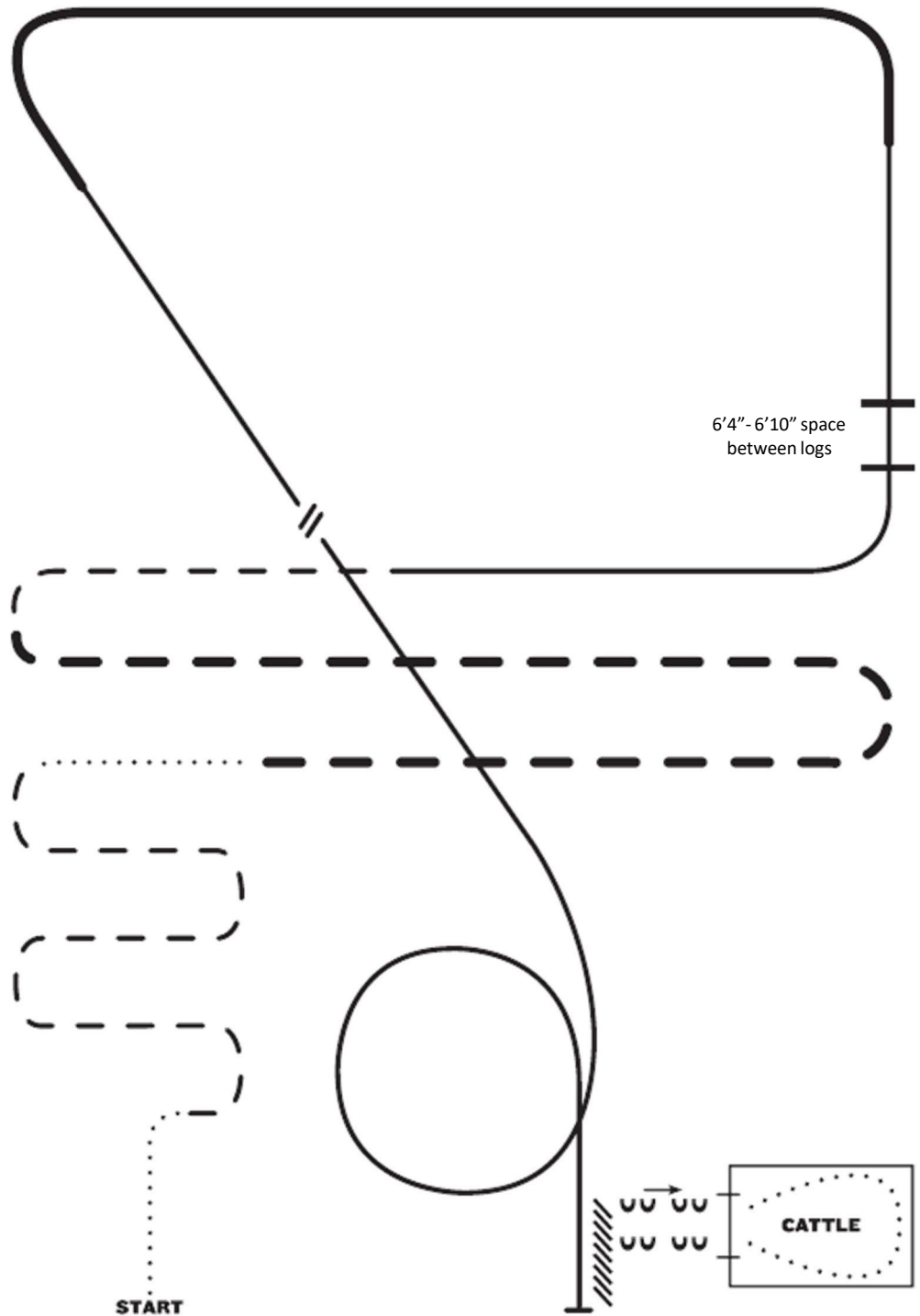
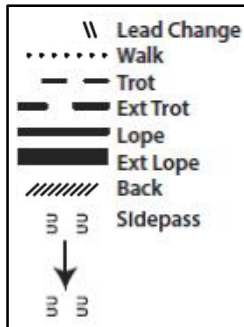

1. Walk
2. Trot serpentine
3. Walk
4. Extended trot
5. Trot
6. Lope left lead
7. Lope over logs
8. Extended lope left lead
9. Collect lope, change leads (simple or flying)
10. Lope right lead
11. Lope circle
12. Stop and back
13. Side pass to gate, left hand push into pen
14. Walk through cattle, right hand push out

RANCH RIDING PATTERN #12

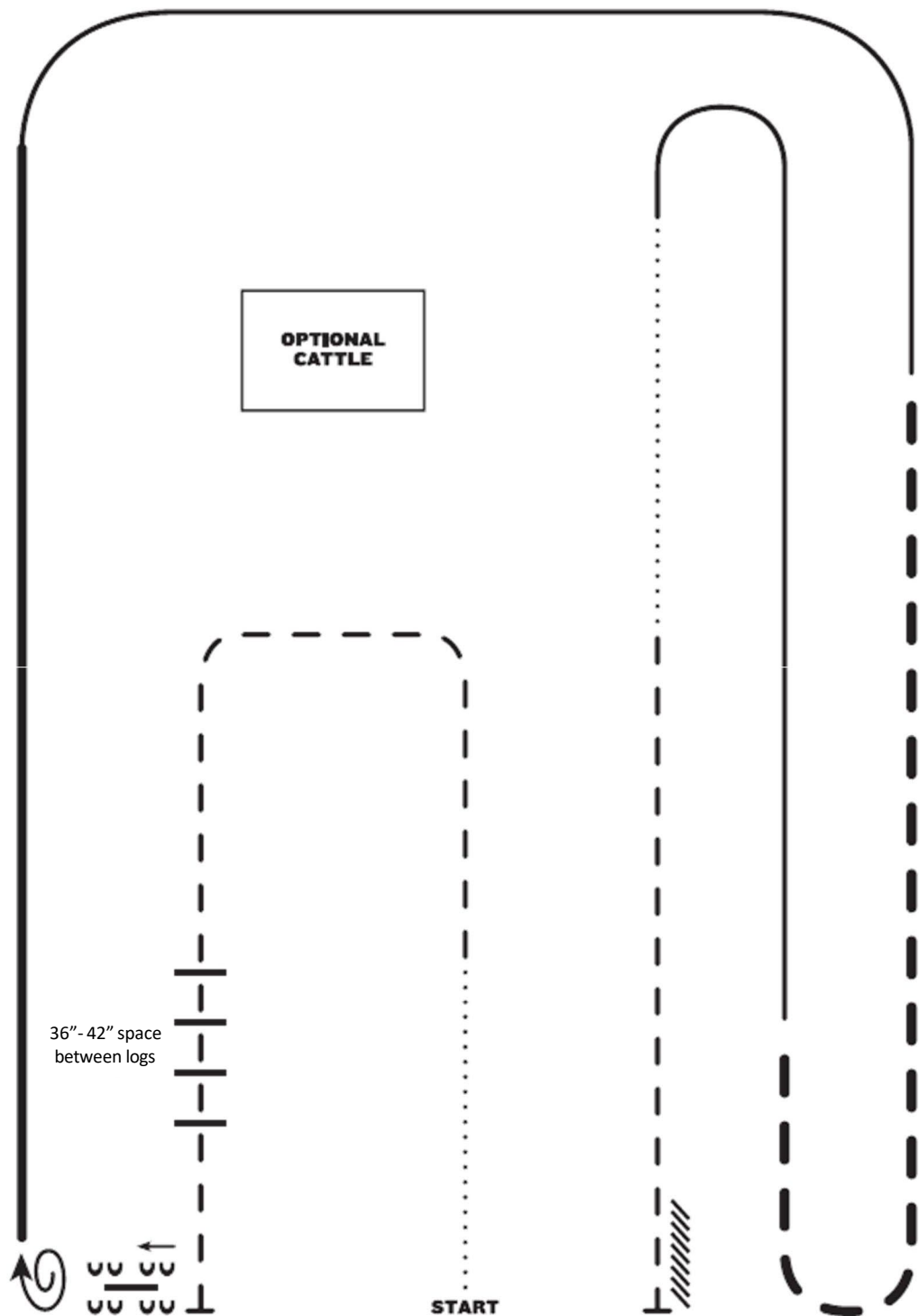
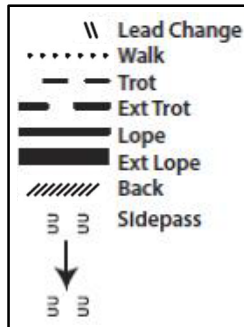

1. Walk
2. Trot
3. Trot over logs, stop
4. Side pass right over log
5. 1 1/2 turn right
6. Extended lope right lead
7. Lope right lead
8. Extended trot
9. Lope left lead
10. Walk
11. Trot
12. Stop and back

RANCH RIDING PATTERN #13

\\	Lead Change
.....	Walk
- - - -	Trot
- - - -	Ext Trot
=====	Lope
=====	Ext Lope
///////	Back

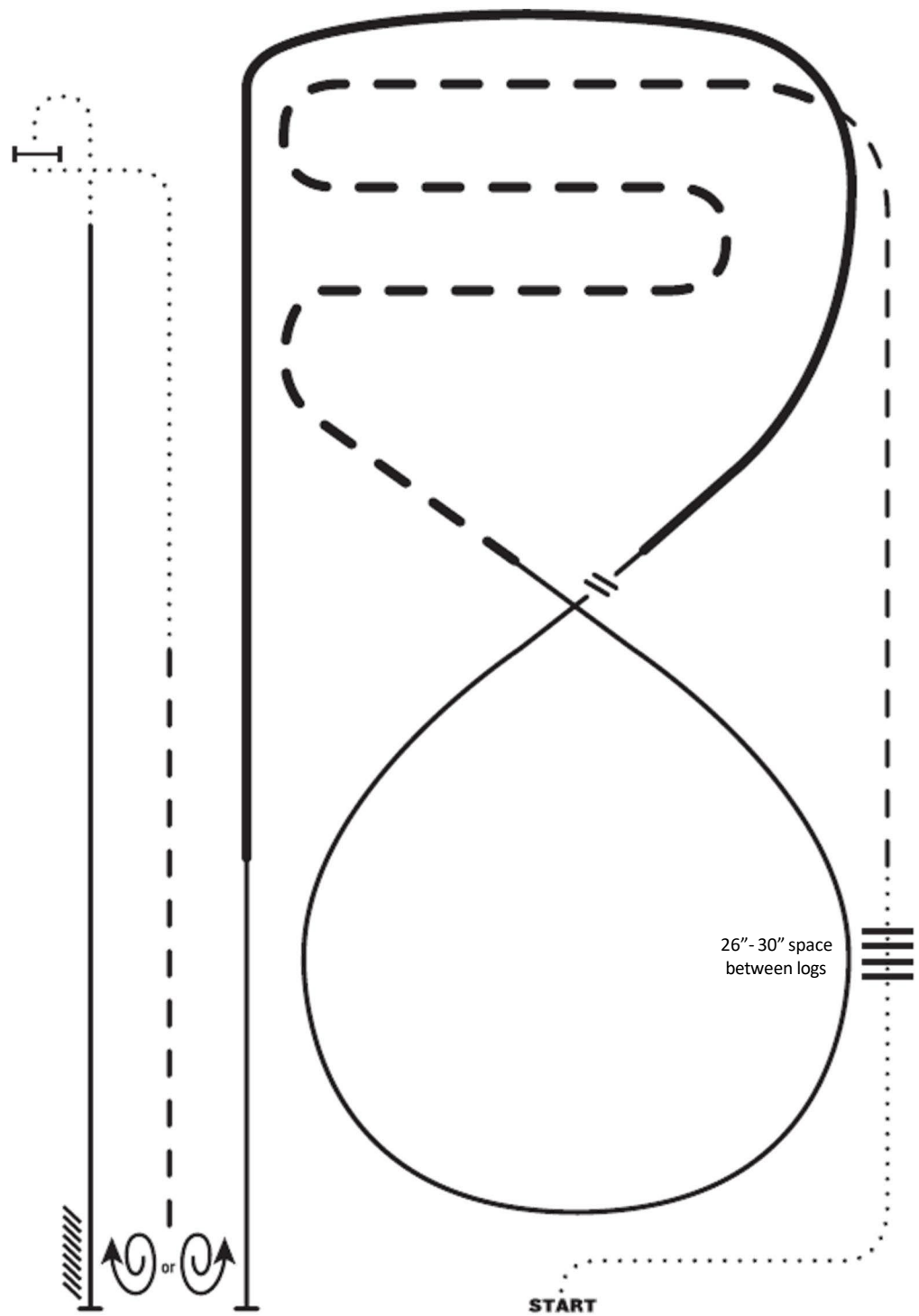

1. Walk
2. Walk over logs
3. Trot
4. Extended trot serpentine
5. Lope right lead
6. Change leads (simple or flying)
7. Extended lope left lead, collect lope
8. Stop, 1 1/2 turn, either direction
9. Trot
10. Walk to gate
11. Right hand push gate
12. Walk, lope left lead
13. Stop and back

RANCH RIDING PATTERN #14

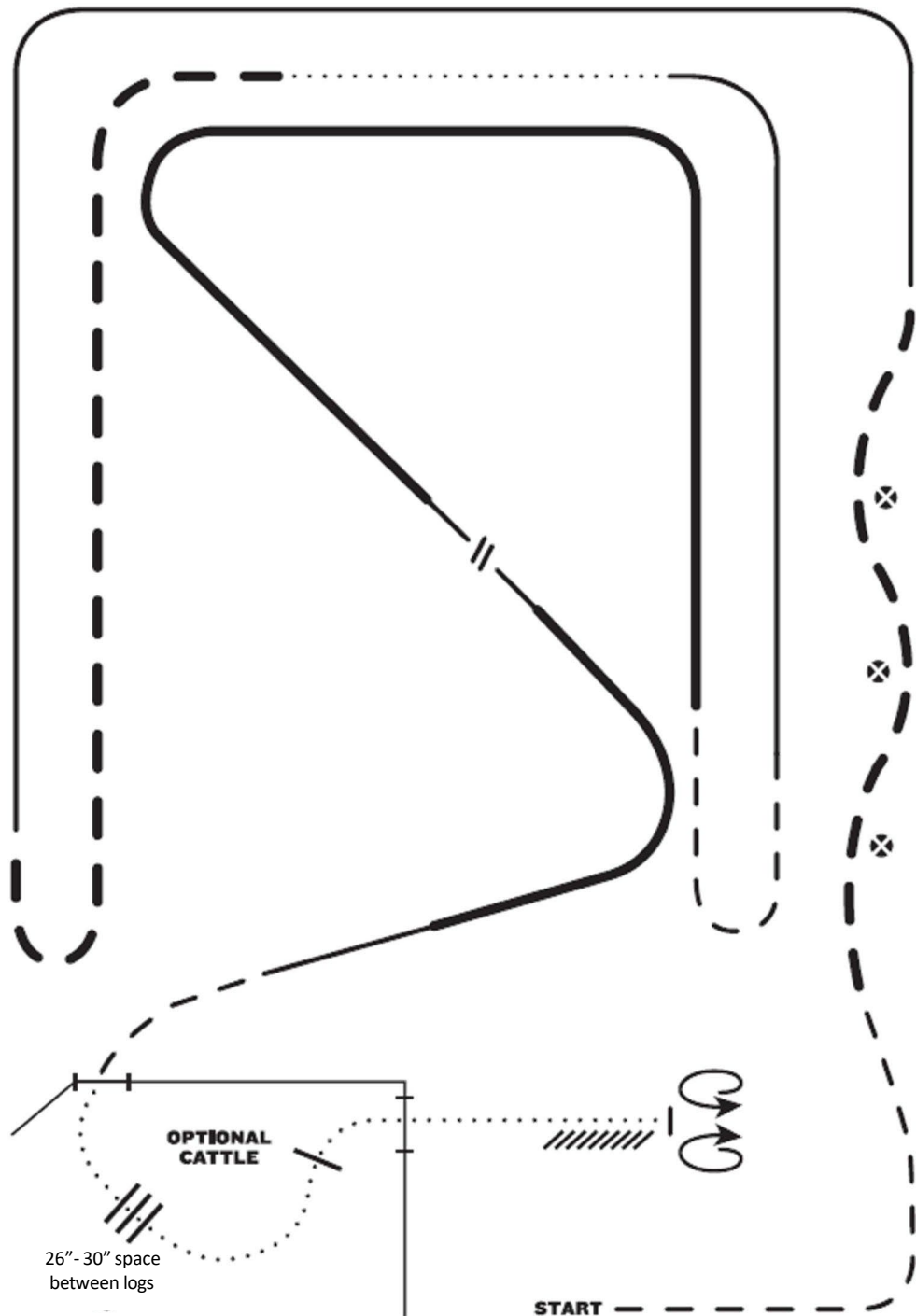
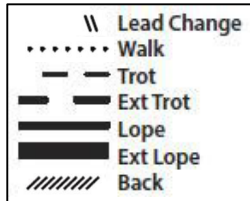

- | | |
|--|--|
| <ol style="list-style-type: none"> 1. Trot 2. Extended trot 3. Lope left lead 4. Extended trot 5. Walk 6. Lope right lead 7. Trot 8. Extended lope left lead 9. Collect lope, change leads (simple or flying), extended lope right lead, collect lope | <ol style="list-style-type: none"> 10. Trot 11. Left hand push gate into pen 12. Walk over logs 13. Right hand push gate out of pen 14. Walk 15. Stop, 360° turn each direction (either direction 1st) (L-R or R-L) 16. Back |
|--|--|

RANCH RIDING PATTERN #15

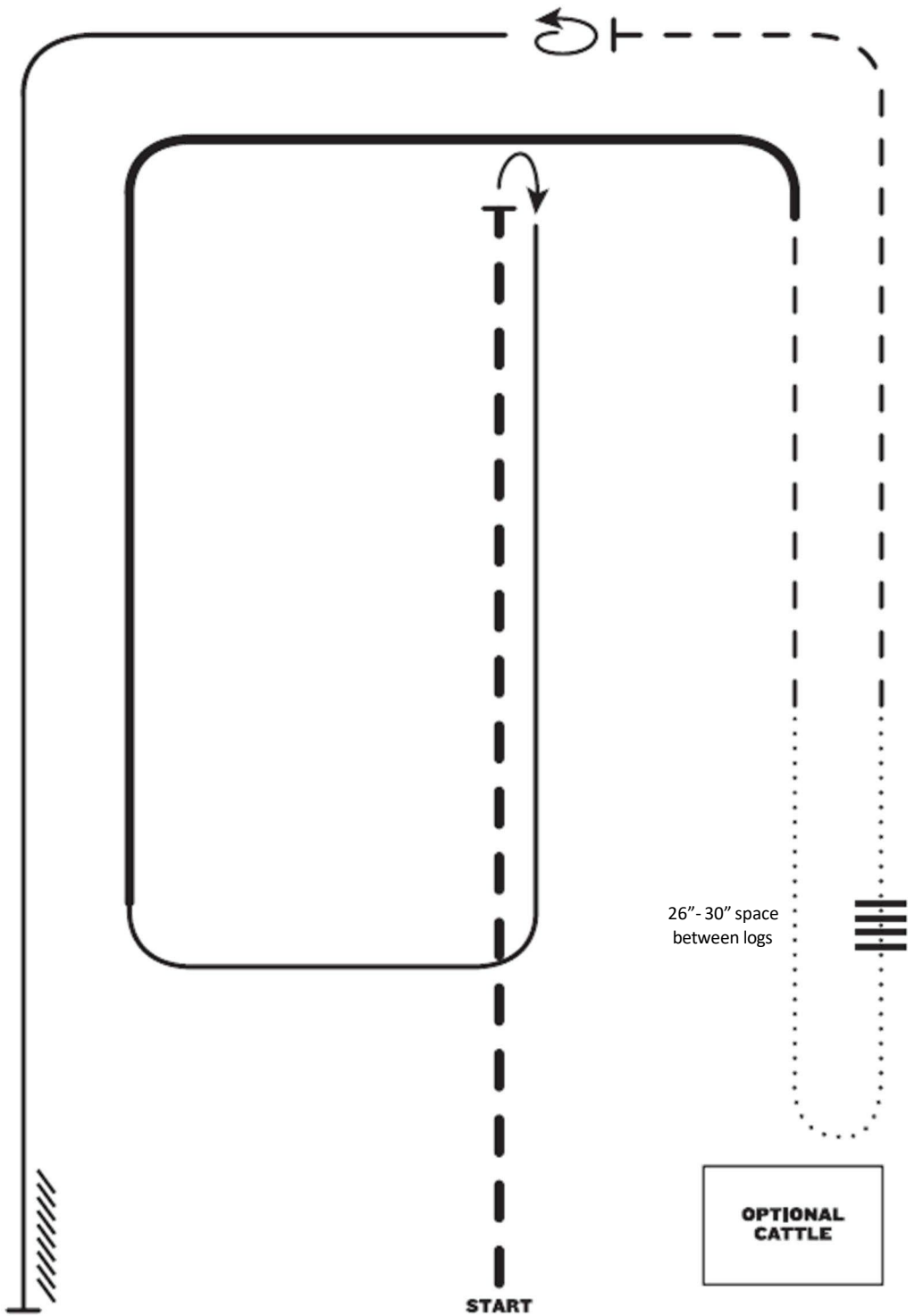
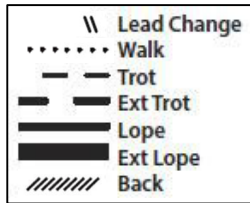

- | | |
|-----------------------------|--------------------------|
| 1. Extended trot | 7. Walk over logs |
| 2. Stop, rollback right | 8. Walk |
| 3. Lope right lead | 9. Trot |
| 4. Extended lope right lead | 10. Stop, 360° turn left |
| 5. Trot | 11. Lope left lead |
| 6. Walk | 12. Stop and back |

RANCH TRAIL, Classes 17–18

1. This class is designed to show the horse's ability to navigate and cope with the various situations and obstacles encountered in everyday ranch work. It is designed to show a horse's ability to perform these obstacles with a willing attitude. The horse is judged on cleanness and promptness with which the obstacles are negotiated, ability to negotiate obstacles correctly, and attitude and mannerisms exhibited by the horse while negotiating the course.
2. Whenever possible, realistic or natural obstacles should be used. The course can be laid outside of the arena using natural terrain. However, if a ground tie is specified in the course, the course must be set up in an enclosed arena.
3. The judge must walk the course and has the right and duty to alter the course in any manner. The judge may remove or change any obstacle he deems unsafe or non-negotiable prior to the start of the class. If at any time a trail obstacle is deemed to be unsafe by the judge, it shall be repaired or removed from the course. If it cannot be repaired and horses have completed the course, the score for that obstacle shall be deducted from all previous works for that class.
4. At least two or three obstacles will be designated as tie breakers and shall be selected prior to the beginning of the competition. One of the mandatory obstacles should be used as the first tie breaker.
5. Tack and Equipment notes:
 - A. Roping gloves may be worn for the duration of the class or may be worn only for the roping and log drag obstacles.
 - B. Romal reins are permitted but must be used with a snap attachment if a ground tie is in the course.
6. Use of hands: Only one hand may be used on reins and hands must not be changed, except to work with an obstacle. Reins may be held in any manner. Two hands may be used when using a snaffle bit or bosal on a horse or pony 5 years of age or younger.
7. The horse will be shown at a ground-covering walk, trot (or natural gait), and lope between the obstacles and credit will be given for performing these gaits on the correct lead with an alert attitude. The walk may be judged as part of an obstacle. Between obstacles, at least 30 feet should be allowed for the trot, and at least 50 feet for the lope. Gaits between obstacles will be scored as part of the next obstacle.
8. Extending the trot/natural gait or lope may also be asked. The extended trot may be ridden with the rider either posting or standing in the stirrups to the front of the saddle. Holding the saddle horn is permissible, at this gait, as might be done in open terrain.
9. The judge may ask a rider to move on to the next obstacle if the horse/rider is unable to complete the maneuver in a reasonable time or if the judge deems that the rider is, or will be, in an unsafe situation. The judge may also ask the rider to move on after a third refusal at an obstacle.
 - A. A rider will lose 15 points if an obstacle is attempted and not completed.
 - B. The maximum points a rider can lose on any one attempted obstacle is 15 points.

10. The judge may excuse a rider from the arena after the second obstacle with three refusals (0 score).
11. No additional credit will be given for unnecessary/exaggerated maneuvers (such as sidepassing to and from an obstacle).
12. Scoring will be on the basis of 0-infinity, with 70 denoting an average performance. Each obstacle will receive an obstacle score that should be added or subtracted from 70 and is subject to a penalty that should be subtracted. Each obstacle will be scored on the following basis, ranging from plus 1½ to minus 1½: -1½ extremely poor, -1 very poor, -½ needs improvement, 0 correct, +½ good, +1 very good, +1½ excellent. Natural ranch horse appearance will also be evaluated ranging from plus 1½ to minus 1½. Obstacle scores are to be determined and assessed independently of penalty points. Penalties should be assessed per occurrence as follows:

(All mentions of jog or trot assume inclusion of "or natural gait.")

A. One (1) Point

- (1) Over-bridled (per maneuver)
- (2) Out of frame (per maneuver)
- (3) Each hit, bite, or stepping on a log, cone, plant, or any component of the obstacle.
- (4) Incorrect or break of gait at walk or jog for two strides or less.
- (5) Wrong lead or out of lead for 2 strides or less.
- (6) Both front or hind feet in a single-strided slot or space at a walk or jog.
- (7) Skipping over or failing to step into required space.
- (8) Split pole in lope-over.
- (9) Incorrect number of strides, if specified.
- (10) One or two steps on mount/dismount, ground tie, and/or picking up hooves (except shifting to balance).

B. Three (3) Points

- (1) Wrong lead or out of lead for more than 2 strides.
- (2) Draped reins.
- (3) Break of gait at walk or jog for more than 2 strides.
- (4) Break of gait at lope (except when correcting an incorrect lead).
- (5) Three to four steps on mount/dismount, ground tie, or picking up hooves.
- (6) Trotting for more than three (3) strides in lope departures or exiting a rollback into a lope from a stop or walk.
- (7) Knocking down or over, or severely disturbing an obstacle.
- (8) Stepping out of or falling off an obstacle with one (1) foot.
- (9) Missing or evading part of a log/obstacle with one (1) foot.

C. Five (5) Points

- (1) Spurring in front of the cinch
- (2) Dropping slicker, log rope, or object required to be carried on course.
- (3) Dropping lariat anywhere on course other than after completion of roping obstacle.
- (4) Each refusal, balk, or evading an obstacle by shying or backing.
- (5) Letting go of gate.
- (6) Use of either hand to instill fear or praise.

- (7) Stepping out of or falling off an obstacle with more than one (1) foot.
- (8) Blatant disobedience (including kicking out, bucking, rearing, striking).
- (9) Moving 5 or more steps during ground tie or picking up hooves.
- (10) Missing or evading part of a log/obstacle with more than one (1) foot.

D. Fifteen (15) Points

- (1) Failure to complete an obstacle once attempted.
- (2) Maximum number of points that can be lost on any one attempted obstacle.

E. Off-Pattern (OP): Cannot place above others who complete pattern correctly

- (1) Breaking pattern. Includes performing the obstacle or an essential element of the pattern incorrectly or other than in specified order, and incorrect line of travel.
- (2) Failure to open or shut gate, or failure to complete gate
- (3) Eliminate or add maneuver
- (4) Repeated blatant disobedience
- (5) Use of two hands (except in snaffle bit or hackamore)

F. Disqualification (DQ)

- (1) Second occurrence of failure to complete an obstacle.
- (2) Abuse
- (3) Lameness
- (4) Disrespect or misconduct
- (5) Illegal equipment
- (6) Fall of horse/rider
- (7) Improper western attire
- (8) Leaving arena before pattern is complete

13. Six to ten obstacles will be used. Three will be mandatory, and the remaining will be selected from the optional list.

A. Mandatory Obstacles:

- (1) Opening, passing through, and closing a gate. This gate may not be a rope gate.
- (2) Log Drag – Horse must be willing to drag a log for a short distance in a straight line or curve to the right (curve may range from a gradual curve to a complete circle or portions of a circle). Rider to pick up rope while mounted at point A and drop rope at point B. Rope may not be tied hard and fast to the saddle horn; dallying is optional. Log size should be roughly the size of a small fence post, suggested maximum weight ~30 lbs. Rope should be securely attached to one end of the post by either drilling a hole through the post and tying a bowline (or other non-slip knot), or attaching an O-ring and tying a non-slip knot through the ring.
- (3) Stationary Steer – This obstacle is used to show the willingness of the horse to have a rope thrown from its back. The judge will give credit to the horse that stands quietly while the contestant makes the swing and throw at the stationary steer. Shying from the rope will be penalized but missing the stationary steer will not be penalized. Rider must provide the rope for this obstacle; rope may be carried in hand, over saddle horn, or affixed to saddle.

At the completion of this obstacle, contestant may coil rope and keep for remainder of class, or drop rope at obstacle without penalty, as directed by the pattern.

B. Optional Obstacles:

- (1) Mailbox – Rider will open and close a mailbox when mounted.
- (2) Bridge – Horse should walk willingly over a bridge. The bridge may be stationary or “teeter-totter” with a 4” maximum rocker pole.
- (3) Slicker – The rider shall show the ability to handle the horse while simulating putting on a slicker. The rider may also be asked to carry the slicker from point A to point B.
- (4) Walk-over log-L obstacle – Walk over 90° log “L”. Log should be no less than 6” and no more than 12” in diameter. Riders should negotiate this obstacle in a straight line.
- (5) Step-overs at a walk, trot, or lope – Natural branches, logs, fence posts, etc. which are laid out in seemingly random angles and distances. Distances should be measured only so the set-up is repeatable, but not for uniform spacing or stride length. Obstacles may not be raised and the maximum height of any step-over is 18”.
- (6) Water hazard – The horse should enter and exit the water hazard in a quiet manner.
- (7) Back through obstacle – Straight, “L,” or into/out of a marked location.
- (8) Sidepass – Straight, one direction, may or may not be elevated.
- (9) Ground Tie – Rider must be able to dismount and walk a minimum of 5 paces away with the horse in a designated spot. If used, this must be the last obstacle of the course (no remount) and class must be held in an enclosed arena. If a rider is using a one-piece rein (romal, roping rein, etc.), it should be unsnapped from the bit on one side while ground-tying.
- (10) Pick up front feet – The rider must be able to dismount and pick up both front feet in an easy, time efficient manner. If used, this must be the last obstacle of the course (no remount). May be used in succession with ground tie so rider only dismounts once per course.
- (11) Live cattle – walk through, near, or around pen of live cattle. The use of cattle could be any degree from a cattle pen set up as a presence on the course to an interactive obstacle.
- (12) Any other safe and negotiable obstacle which could reasonably be found in everyday ranch work and meets the approval of the judge.

C. If disrupted, the course shall be reset. In the case that an obstacle is used in combination, the obstacle cannot be reset until the contestant finishes the entire combination.

RANCH REINING, Class 19

1. The ranch reining class measures the ability of the ranch horse to perform basic handling maneuvers with a natural head carriage in a forward-looking manner. Patterns may be chosen from any of the ranch reining patterns or approved by the show management and judge. Each horse will be judged on the neatness, dispatch, ease, calmness, and speed with which it performs the pattern.

2. To rein a horse is not only to guide him but also to control his every movement. The best reined horse should be willingly guided or controlled with little or no apparent resistance and dictated to completely. Any movement on his own must be considered a lack of control. All deviations from the exact written pattern must be considered a lack of or temporary loss of control and therefore a fault that must be marked down according to severity of deviation. The horse/rider team's overall performance should be credited for smoothness, finesse, attitude, quickness, and authority of performing various maneuvers while using controlled speed which raises the degree of difficulty and makes the horse/rider team more exciting a pleasing to watch.
3. Scoring will be on the basis of 0 to 100, with the run beginning with a score of 70 points. The individual maneuvers are scored in ½ point increments from a low of -1 ½ to a high of +1 ½ with a score of 0 denoting a maneuver that is correct with no degree of difficulty. Natural ranch horse appearance will also be evaluated ranging from plus 1½ to minus 1½. Pluses and minuses are a reflection of the smoothness, finesse, attitude, quickness and authority of the horse/rider team when performing the various maneuvers. Penalties may be accrued for incorrect maneuver execution.

All runs begin upon entering the pen and any infractions are subject to penalty at that time.

A. The following will result in a reduction of one-half (½) point:

- (1) Starting a circle or exiting a rollback at a trot for up to two strides.
- (2) Delayed change of lead by one stride where the lead change is required by the pattern description.
- (3) Failure to remain a minimum of twenty feet from the wall or fence when approaching a stop and/or rollback.
- (4) Over-spin or under-spin up to 1/8 turn.

B. The following will result in a reduction of one (1) point:

- (1) Over-bridled (per maneuver)
- (2) Out of frame (per maneuver)
- (3) Out of lead in the circles, figure eights, or around the end of the arena (this penalty is cumulative and will be deducted for each quarter of a circle the horse is out of lead).
- (4) Over or under spinning 1/8 to 1/4 turn.
- (5) Slipping rein.

C. The following will result in a reduction of two (2) points:

- (1) Break of gait.
- (2) Freezing in spins or rollbacks.
- (3) Failure to completely pass the specified marker before initiating a stop position.
- (4) Trotting beyond two strides, but less than 1/2 circle or 1/2 length of the arena.
- (5) Failure to stop or walk before executing a lope departure on trot-in patterns.
- (6) Failure to be in a lope prior to the first marker on run-in patterns.

D. The following will result in a reduction of five (5) points:

- (1) Spurring in front of cinch.
- (2) Use of free hand to instill fear/praise.
- (3) Blatant disobedience (including kicking, biting, bucking, and rearing).

E. Off-Pattern (OP): Exhibitors cannot place above others who complete the pattern correctly.

- (1) breaking pattern
- (2) inclusion of maneuver (e.g., over or under-spinning, backing more than two (2) strides, etc.)
- (3) trotting in excess of 1/2 circle or 1/2 length of the arena
- (4) repeated blatant disobedience
- (5) use of two hands (except junior horses shown in a snaffle bit/ hackamore)

F. Disqualification (DQ)

- (1) Lameness
- (2) Abuse of an animal in the show arena and/or evidence that an act of abuse has occurred prior to or during the exhibition of a horse in competition.
- (3) Use of illegal equipment or bits.
- (4) Disrespect or misconduct by the exhibitor.
- (5) Leaving arena before pattern is complete.
- (6) Improper western attire
- (7) Fall of horse/rider

4. For all patterns, the judge shall indicate with markers on or along arena fence or wall the length of the pattern. Markers within the area of the pattern will not be used.

RANCH REINING PATTERN 1

Mandatory Markers:

The judge shall indicate with markers on arena fence or wall the center of pattern.

Ride pattern as follows:

Trot to center of arena and stop.

1. Complete 3 spins in one direction. Hesitate.
2. Complete 3 spins in the opposite direction. Hesitate.
3. Beginning on right lead, complete two large fast circles to the right, change leads.
4. Complete two large fast circles to the left, change leads at center of arena.
5. Begin a large circle to the right but do not close this circle. Run down the right side of the arena past the center marker and do a left roll back at least 20 feet from the wall or fence, no hesitation.
6. Continue back around the previous circle but do not close this circle. Run down the left side of the arena past the center marker and do a right roll back at least 20 feet from the wall or fence, no hesitation.
7. Continue back around previous circle but do not close this circle. Run down the right side of the arena past the center marker and do a sliding stop at least 20 feet from the wall or fence. Back up at least 10 feet.

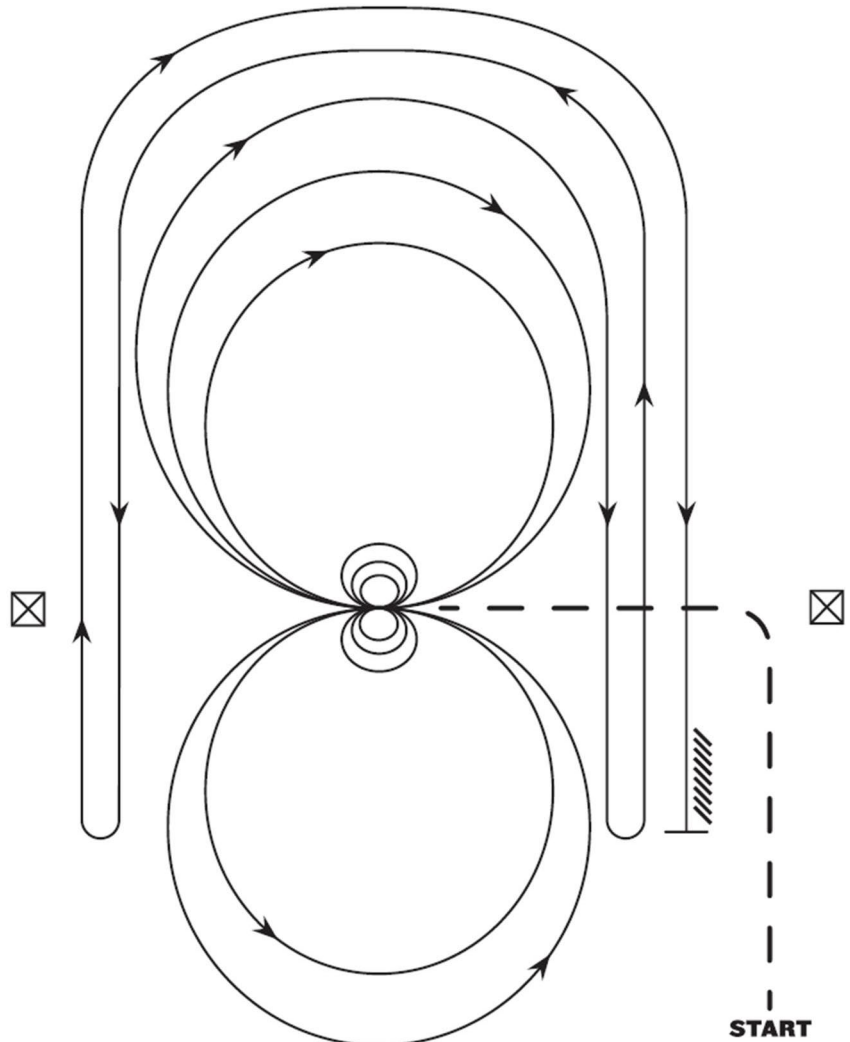

Hesitate to show completion of pattern.

RANCH REINING PATTERN 2

Mandatory Markers along fence:

The judge shall indicate with markers on arena fence or wall the center of pattern.

Ride pattern as follows:

Start by trotting into center of arena and either stop or walk before departure.

1. Beginning on right lead, complete two circles to the right – the first one large and fast; the second one small and slow. Stop at center.
2. Complete 4 spins to the right. Hesitate.
3. Beginning on left lead, complete two circles to the left – the first one large and fast; the second one small and slow. Stop at center.
4. Complete 4 spins to the left. Hesitate.
5. Beginning on the right lead, complete a large fast circle to the right and change leads at center of arena. Complete a large fast circle to the left and change leads at center of arena.
6. Begin a large fast circle to the right, but do not close this circle. Run down the right side of the arena, past the center marker, and do a left roll back at least 20 feet from the wall or fence.
7. Continue back around the previous circle, but do not close this circle. Run down the left side of the arena, past the center marker, and do a right roll back at least 20 feet from the wall or fence.
8. Continue back around previous circle, but do not close this circle. Run down right side of the arena, past the center marker, and do a sliding stop at least 20 feet from the wall or fence. Back up at least 10 feet.

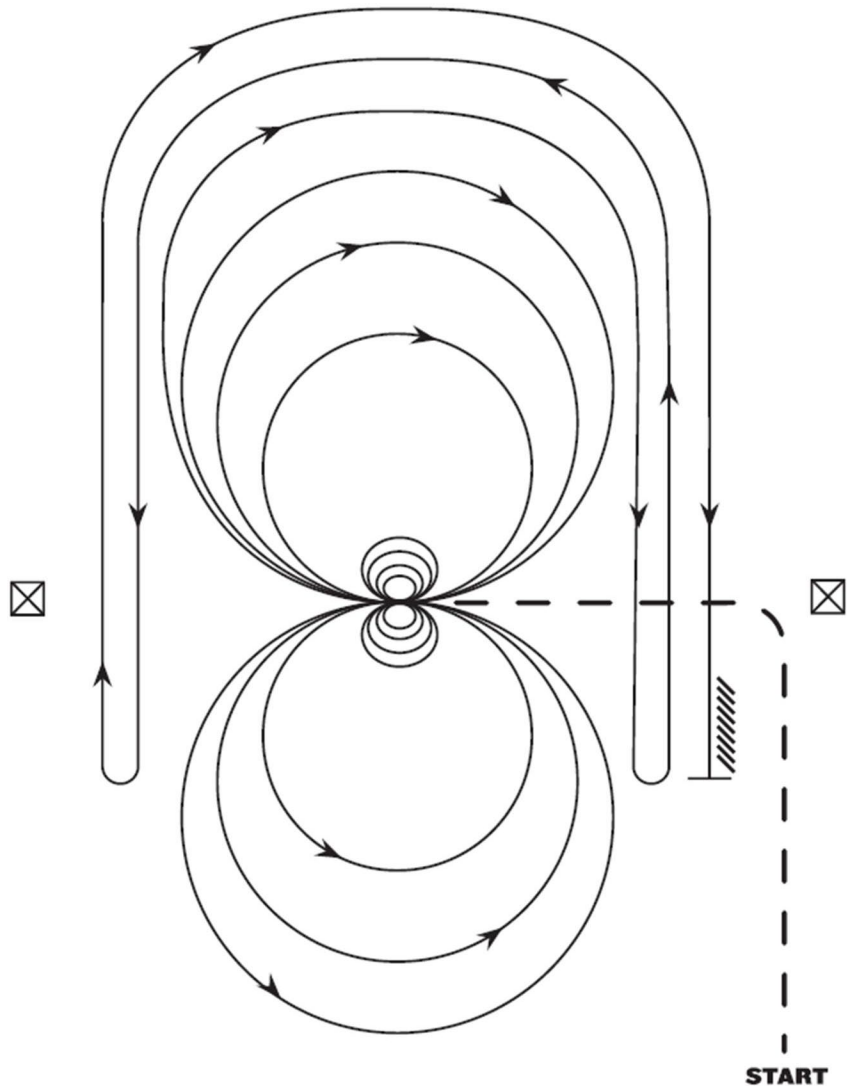

Hesitate to show completion of pattern.

RANCH REINING PATTERN 3

Mandatory Markers along fence:

The judge shall indicate with markers on arena fence or wall the center of pattern. Judge shall also place markers on fence or wall at least 50' from each end of the arena.

Ride pattern as follows:

Start by trotting into center of arena and stop. Start pattern facing toward judge.

1. Beginning on right lead, complete 3 circles to the right – the first two large and fast; the third one small and slow. Change leads at center of arena.
2. Complete 3 circles to the left – the first two large and fast; the third one small and slow. Change leads at center of arena.
3. Begin a large circle to the right, but do not close this circle. Run down center of arena, past the end marker, and do a sliding stop.
4. Complete 3 ½ spins to the right.
5. Run up center of arena to the opposite end, past the end marker, do a sliding stop.
6. Complete 3 ½ spins to the left.
7. Run back to the middle of the arena, past the center marker, and do a sliding stop. Back up at least 10 feet.

Hesitate to show completion of pattern.

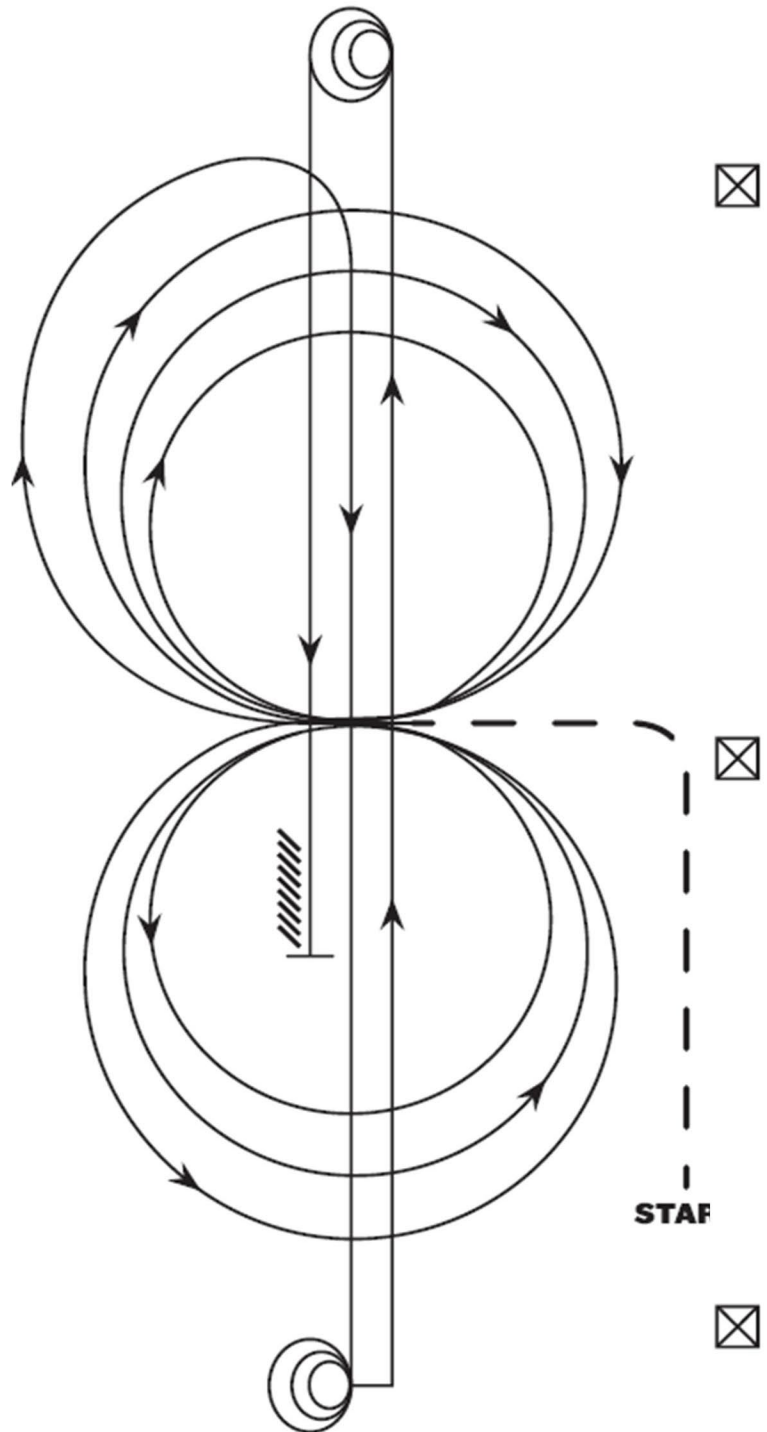

RANCH REINING PATTERN 4

Mandatory Markers along fence:

The judge shall indicate with markers on arena fence or wall the center of pattern. Judge shall also end place markers on fence or wall at least 50' from each end of the arena.

Ride pattern as follows:

1. Run up center of arena past the end marker and do to a sliding stop
2. Complete 3 ½ spins to the left
3. Run down to opposite end of arena, past the end marker and do a sliding stop.
4. Complete 3 ½ spins to the right
5. Run past the center marker and do a sliding stop. Back at least 10 feet. Complete ¼ turn to the left, hesitate.
6. Beginning on right lead, complete two circles to the right, the first one small and slow, the second large and fast. Change leads at center of arena.
7. Complete two circles to the left, the first one small and slow, the second one large and fast. Change leads at the center of arena.
8. Begin a large circle to the right but do not close this circle. Run down the right side of the arena, past the center marker and do a sliding stop at least 20 feet from the fence.

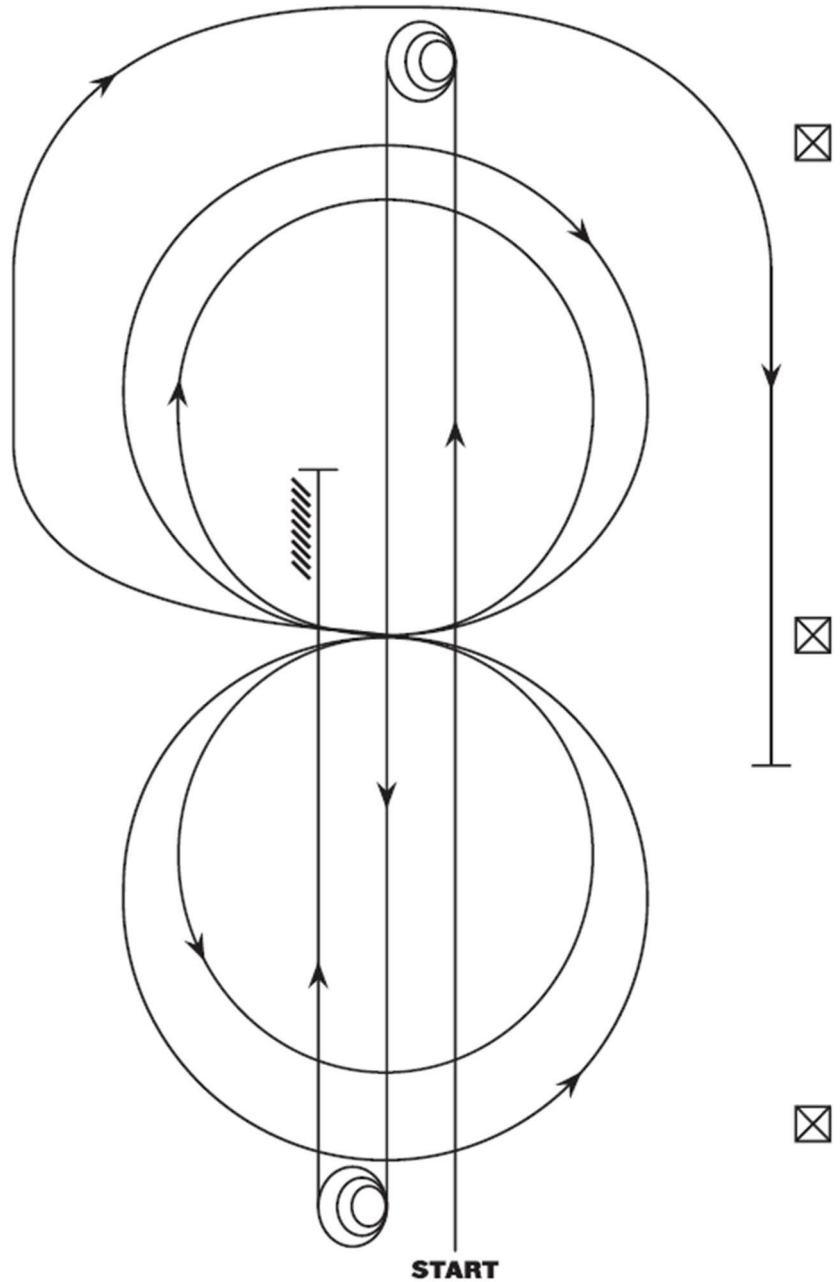

Hesitate to show completion of pattern.

RANCH REINING PATTERN 5

Mandatory Markers along fence:

The judge shall indicate the area for the pattern with six markers on arena fence. Judge shall also place markers on fence or wall at least 50' from each end of the arena.

Ride pattern as follows:

1. Run past the center marker and do a sliding stop. Back to center of arena or at least 10 feet. Hesitate.
2. Complete 4 right spins. Hesitate.
3. Complete 4 $\frac{1}{4}$ left spins. Hesitate. Horse to be facing left fence.
4. Beginning on the left lead, complete two circles to the left. First circle to be small and slow and second circle to be large and fast. Change leads at the center of the arena.
5. Complete two circles to the right. First circle to be small and slow and second circle to be large and fast. Change leads at center of arena.
6. Begin a large circle to the left, but do not close this circle. Run up the right side of the arena, past the center marker, and do a right rollback at least 20 feet from the fence.
7. Continue back around the previous circle, but do not close circle. Run up the left side of the arena, past the center marker, and do a left rollback at least 20 feet from the fence.
8. Continue back around previous circle, but do not close this circle. Run up the right side of the arena, past the center marker, and do a sliding stop at least 20 feet from the fence.

Hesitate to show completion of pattern.

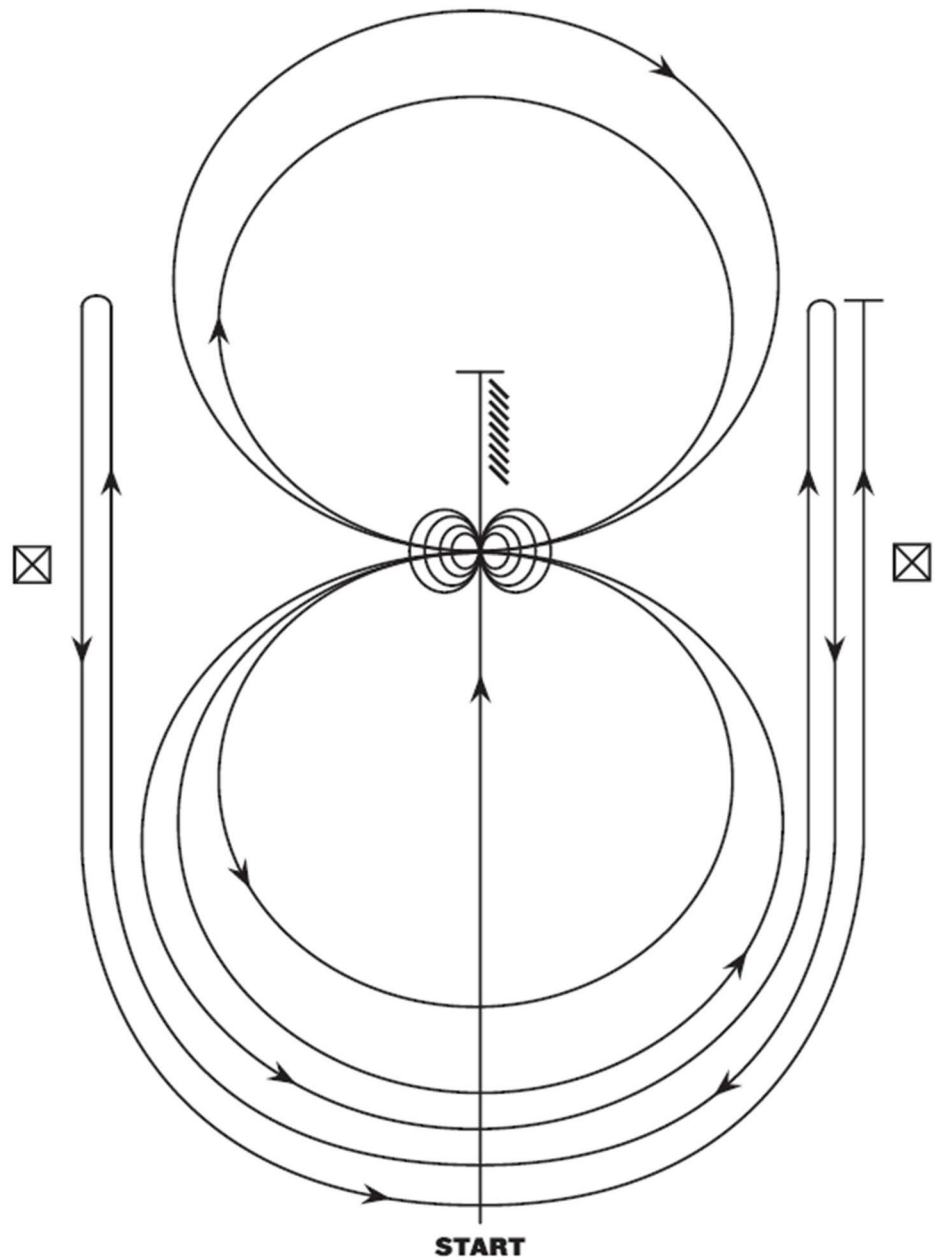

RANCH REINING PATTERN 6

Mandatory Markers along fence:

The judge shall indicate with markers on arena fence or wall the center of pattern. Judge shall also place markers on fence or wall at least 50' from each end of the arena.

Ride pattern as follows:

Trot to center of arena and stop or walk before departure. Start pattern facing toward judge.

1. Beginning on right lead, lope one circle to the right. Change leads at the center of the arena.
2. Complete one circle to the left. Change leads at the center of the arena.
3. Begin a circle to the right, but so not close this circle. Run down the center of arena, past the end marker, and do a sliding stop.
4. Complete 3 ½ spins to the right
5. Run up to other end of arena, past the end marker, do a sliding stop.
6. Complete 3 ½ spins to the left
7. Run past the center marker and do a sliding stop. Back at least 10 feet.

Hesitate to show completion of pattern.

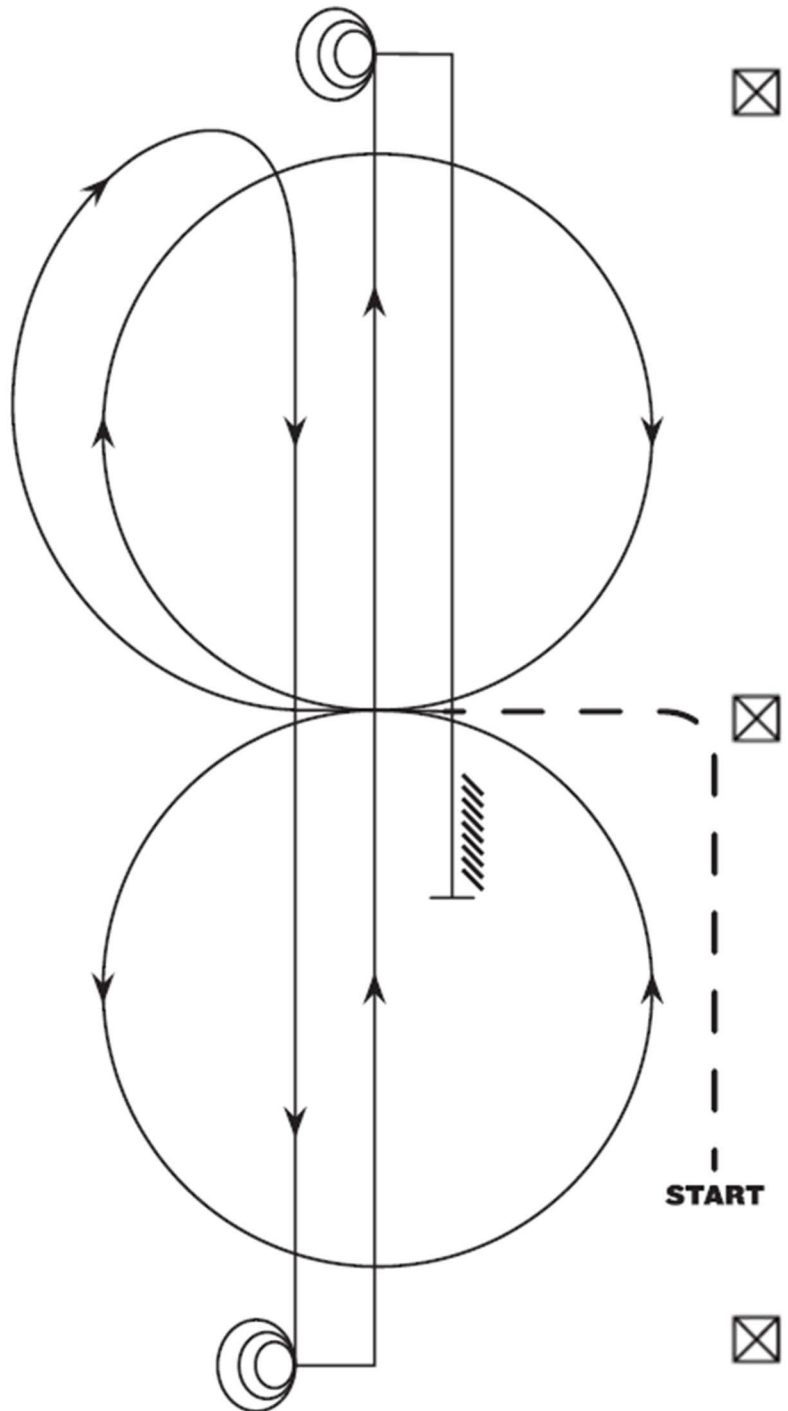

RANCH REINING PATTERN 7

Mandatory Markers along fence:

The judge shall indicate with markers on arena fence or wall the center of pattern. Judge shall also place markers on fence or wall at least 50' from each end of the arena.

Ride pattern as follows:

Trot to center of arena and stop or walk before departure. Start pattern facing toward judge.

1. Beginning on left lead, complete two circles to the left – the first one large and fast, the second one small and slow. Change leads at center of arena.
2. Complete two circles to the right – the first one large and fast, the second one small and slow. Change leads at center of arena.
3. Begin a circle to the left, but do not close this circle. Continuing around the end of arena, run up the center, past end marker, and do a sliding stop.
4. Complete 3 ½ spins to the left.
5. Run down to other end of arena, past the end marker, and do a sliding stop.
6. Complete 3 ½ spins to the right.
7. Run past the center marker and do a sliding stop. Back at least 10 feet.

Hesitate to show completion pattern

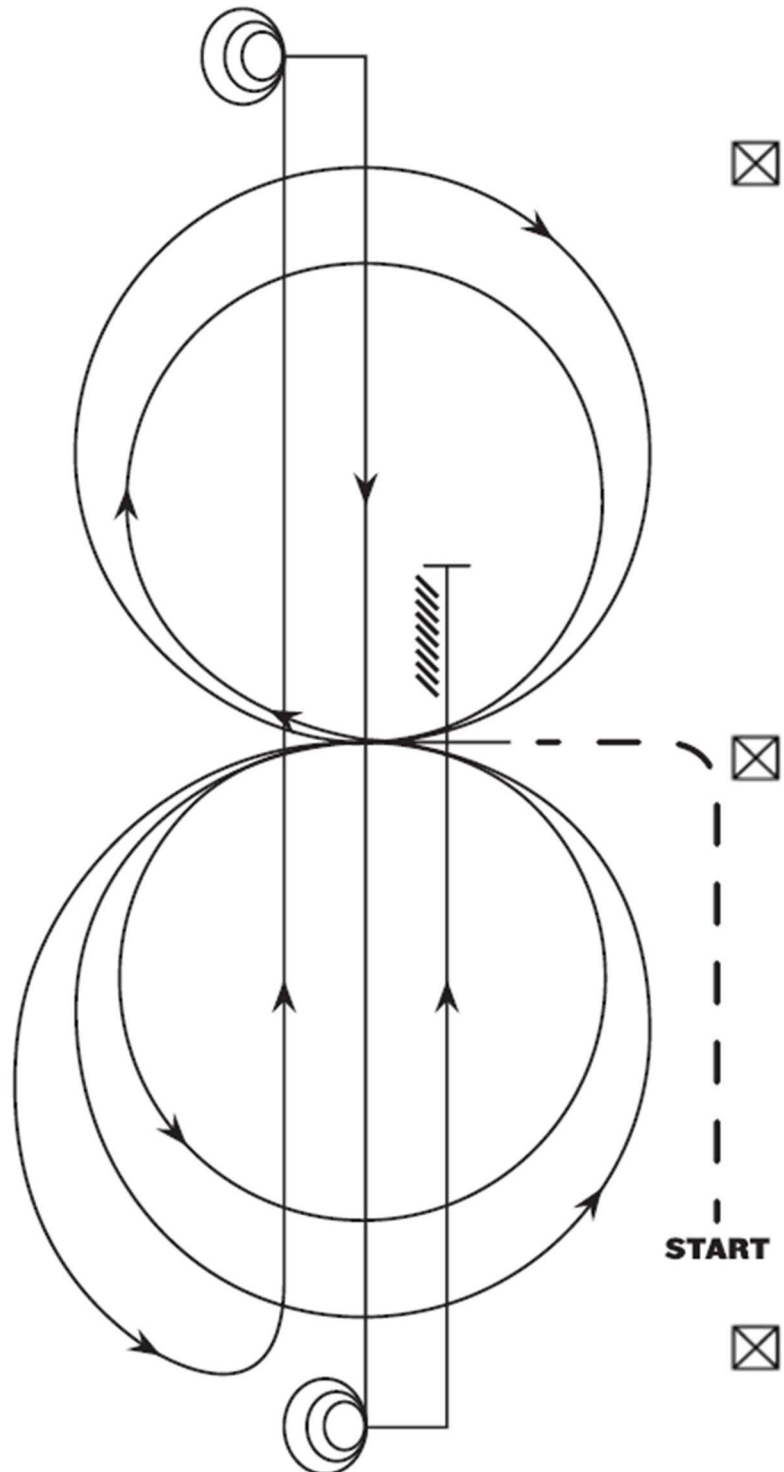

RANCH ROPING, Class 20

1. The idea of this class is to show the ability of the horse and rider's skill in handling cattle as if they were doctoring injured or sick cattle. Cattle should be handled as calmly and slowly as possible. The judge should judge this class as if the cattle belonged to him or her. Entry does not have to separate the cow from herd and should not receive credit for separation from herd. If the cow is separated from the herd, there should be no excessive running or cutting of the cow.
2. This is a judged event with a 2-minute time limit. There shall be a 30 second warning given prior to the end of the run. The rope must be thrown, and the contestant may rebuild and throw an unlimited number of loops. No credit will be given for additional loops after a successful catch of any part of the animal. The honda on the rope used must be of a breakaway design. Ropes may not be tied hard and fast to the saddle horn.
3. The arena for this event will be shortened with the addition of portable panels. The exhibition area should typically be normal width of the arena (usually 100 to 150') by 45' – 75'. Show management or the judge may make adjustments to the size of the arena to allow for the temperament of the cattle.
4. Horse and rider must start from an entrance gate which will be opposite from where ten (10) calves/yearlings are held as a herd with each bearing a number 0 - 9. A random draw will be used to select the calf to be roped, which will be announced to the contestant when the horse enters the arena gate.
5. The show committee will provide 2-4 herd holders. The sole duty of the herd holders is to settle the cattle between runs.
6. The contestant should make a desired catch, position their horse in an appropriate manner and dally up. A desired catch is defined as one in which the animal is roped, and the rope comes tight in front of the animal's shoulders. A catch of any other part of the animal shall be considered legal but the exhibitor will receive a penalty. When the calf breaks free from the honda, the Flag Judge will signal the end of the run.
7. Failure to make a legal catch will result in a 25-point penalty. However, the contestant's performance will be scored and allowed to place accordingly. At no time may a roper with no catch be placed above a roper with a successful catch.
8. Scoring will be on the basis of 0 to 100, with 70 denoting an average performance.
9. Each maneuver will be scored from a plus three (+3) to minus three (-3) in ½ point increments.
 - Ability to sort
 - Stopping
 - Ability to rope out of the herd without disturbing other cattle
 - Dallying
 - Ability to manage coils
 - Ability to manage rope and position of horse while dallying
 - Difficulty of a throw that results in a successful catch.

10. Penalties

- A. Twenty-five (25) point penalty
 - (1) Failure to catch.
- B. Twenty (20) point penalty
 - (1) Incomplete dally.
- C. Ten (10) point penalty
 - (1) Roping any portion of the cow other than the head/neck.
- D. Five (5) point penalty
 - (1) Multiple loop run (penalty may be assessed for each rebuild with a maximum of 15 points taken)
 - (2) Running/scattering of the herd
 - (3) Blatant disobedience including kicking, biting, rearing, or striking
 - (4) Inability of rider to efficiently recoil and build a loop after a miss
- E. Three (3) point penalty
 - (1) Holding cut too long without roping
- F. One (1) point penalty
 - (1) Loss of cow (re-cut in the herd)
- G. Zero (0) score / DQ
 - (1) Running into or over cattle
 - (2) Schooling
 - (3) Whipping or hitting horse with rope
 - (4) Thrown from horse
 - (5) Fall to ground
 - (6) Loss of rope
 - (7) Bucking
 - (8) Roping wrong cow
 - (9) Roping more than 1 cow with the same loop
 - (10) Excessive running of the cattle

WORKING COW HORSE, BOXING ONLY, Class 21

- 1. This class has been designed to demonstrate the horse's ability to do cow work.
- 2. The show committee may provide 2-4 herd holders to facilitate returning the cow to the holding pen after each run. Markers will be placed approximately 25' from the end of the arena.

3. After calling for the cow, there will be a 50 second time limit for cow work in this class. Time shall begin when the gate closes behind the cow after being let into the arena. At 50 seconds, the announcer will call time. If a contestant completes the work before the 50 second time is completed, the judge may blow a whistle to indicate that all requirements of the class have been met. The judge may also blow a whistle at any time for the contestant to cease work for safety reasons.
4. Boxing the Cow – The rider will face the cattle entry gate. The rider shall signal for his/her cow to be turned into the arena. Upon entry into the arena, the cow shall be controlled on the entry end of the arena for a sufficient amount of time to demonstrate their horse's ability to "hold" the cow. If the cow does not immediately challenge the horse, the rider shall aggressively move in on the cow to demonstrate the horse's ability to drive and block the cow on the entry fence.

This is not a fence turn class. If control of the cow is lost, rider should not chase up the side of the arena and do a fence turn, however, should attempt to return the cow to the desired end of the arena in a quiet manner.

5. The judge should take into consideration the size of the arena, condition of ground and the disposition and degree of difficulty exhibited by the cattle worked.
6. The judge may blow his/her whistle at any time during the work. One whistle to terminate the work, two whistles to award a new cow. If the judge awards a new cow, the exhibitor has the option to refuse the new cow by continuing to work. There shall be no schooling between cows if a new cow is awarded. If the exhibitor intends to accept the new cow, he or she must pull up immediately. If at any time a judge feels that the contestant is out of control endangering themselves and/or their horse, the judge may terminate the work, and a score of zero will be given. In the case of an emergency (such as a person falling into the arena or part of the arena falling apart) the judge may blow two whistles for a second time. At this point, the contestant has no option to continue and must receive a new cow. Contestant must pull up immediately or a score of zero will be given. Judging ends when the whistle blows.
7. Scoring will be on the basis of 0 to 100, with 70 denoting an average performance. Run content will be scored from a plus three (+3) to minus three (-3) in ½ point increments. Run content includes boxing, run & rate, position & control, degree of difficulty, eye appeal, and courage/time worked. The entry shall be penalized for:
 - A. Five (5) Point Penalties
 - (1) Deliberate spurring forward of the cinch
 - (2) Blatant disobedience defined as kicking, biting, bucking, rearing, striking or obviously insubordinate
 - (3) Performing an intentional fence turn by horse or rider
 - B. Three (3) Point Penalties
 - (1) Loss of control and cow leaves end of arena
 - C. One (1) Point Penalties
 - (1) Loss of working advantage
 - (2) Working out of position

D. Zero (0) Score

- (1) Turn tail
- (2) Leaving the work area before time expires
- (3) Any horse that is out of control while working the cow, thus endangering the rider (i.e., crossing the path of the cow) shall be called off the cow.
- (4) Running cow into back fence with force
- (5) During the cow work, use of two hands on the reins, except with junior horses ridden two-handed in a bosal or snaffle bit
- (6) Bloody mouth (inside)
- (7) Balking
- (8) Schooling between cows, if a new cow is awarded
- (9) The judge may blow the whistle at any time to terminate the work, a score of zero will be charged if the work is not complete at that point

E. No Score (DQ)

- (1) Abuse
- (2) Lameness
- (3) Fall of horse and/or rider

8. If time and number of cattle permits, the judge may, at their discretion, award new cattle, to enable the contestant to show their horse's ability on the cow, based on the following criteria:
 - A. The cow won't or can't run
 - B. The cow runs blind or won't yield to the horse
 - C. The cow leaves the arena

RANCH RAIL, Classes 22 & 23

1. The ranch rail class measures the ability of the horse to be a pleasure to ride and should reflect the versatility, attitude, and movement of a working ranch horse needing to cover long distances softly and quietly. The horse should be well-broke, relaxed, and cadenced at all gaits. This class should show the horse's ability to work at a forward, working pace while under control of the rider. The overall manners and responsiveness of the horse and horse's quality of movement are primary considerations in judging this class. The horse should be ridden with a natural head carriage on a relatively loose rein with light contact.
2. All exhibitors will work as a group on the rail. Horses must work both ways of the ring at the walk, trot, and lope. At the option of the judge, horses may work at least one way in the ring at the extended walk, extended trot, and extended lope.
 - A. Finalists may be asked to back either on the rail or in the center of the arena.
 - B. It is acceptable for exhibitors to touch or hold the saddle horn during any of the extended gaits.
3. When showing in a snaffle bit (five years of age or younger), the exhibitor may switch between two hands and one hand on the reins at the extended gaits.

4. Contestants must use split reins or romal – roping reins are not permitted. Only one finger between reins is permissible.
 5. Faults scored according to severity –
 - A. Too slow or excessive speed at any gait
 - B. Over-bridled (nose behind the vertical)
 - C. Head carried too low such that the poll is below the withers
 - D. Out of frame or head carried too high
 - E. Break of gait
 - F. Wrong lead or out of lead
 - G. Opening mouth excessively
 - H. Draped reins
 - I. Use of spurs forward of the cinch
 - J. Canted at the lope
 - K. Blatant disobedience (kick, bite, buck, rear, etc.)
 6. A horse that consistently and excessively holds its head too low and/or clearly behind the vertical while in motion, showing the appearance of intimidation, can be cause for disqualification.
 7. An exhibitor/horse combination may NOT enter both Western Pleasure and Ranch Rail at the same show.
-

SPEED EVENTS DIVISION (Classes 24–33)

APPOINTMENTS:

PERSONAL: Clothing should be clean and neat. Riders shall wear western boots (no tennis shoes or sport shoes are acceptable) and western dress pants or jeans. Shirts must have a collar and sleeves (long or short) or be appropriate show attire (i.e., slinkies, band collars, turtlenecks). All exhibitors are required to wear an SEI or SEI/ASTM approved equestrian safety helmet with fastened chin harness in every class (see rule #6 on page 7).

TACK: Western-type saddles will be used. Use of two hands on the reins is allowed in speed events. A judge or show official shall have the authority to require the removal or adjustment of any piece of equipment which in their opinion is unsafe, would give a horse an unfair advantage, or constitute excessive harshness or cruelty. Use of standing martingales, tie-downs, and nosebands is permitted in these classes. Draw reins, including tack that has the action of draw reins, and any other kind of martingales are not allowed in speed events. Horses may wear protective boots, but bandages (leg wraps) are not permitted in any speed event class. **See Bits section (page 11-12) for description of legal bits for Speed Events.**

1. These contests are strictly timed events. The contestant is allowed a running start. Timing shall begin as soon as the horse's nose crosses the starting line and will be stopped when the horse's nose passes over the finish line.
2. Horse must be under the control of the rider upon entrance and exit of arena or stopping area and promptness in entering the arena is expected. No horse or rider will be assisted once inside the arena (past the plane of the gate). Failure to comply will result in disqualification.
 - A. Horses must be started inside the arena unless an enclosed boxed area is available adjacent to the arena.
 - B. In-gate must be closed before contestant begins their run. Failure to do so will result in disqualification. When a box is used, the gate to the arena will not be opened until the entry gate is closed. At that point, the contestant may run out of the box.
 - C. The exit gate of the arena will not be opened until the horse is stopped and under control.
 - D. Show management reserves the right to refuse an exhibitor entry into any class or event if they deem that entry unsafe for the exhibitor and/or other exhibitors, animals, or show staff. With the exhibitor's safety in mind, any activity or situation deemed unsafe can and will be stopped by show management and may result in disqualification from that class. (Examples to consider are unruly horse attempting to enter the arena, unsafe mounting inside the arena, etc.)
3. When accessible, an electric timer will be used for official time.
State show only: When an electric timer is used all timed events will be backed up by at least two stop watches. In the event of a malfunction by the electric timer, contestant will be given the option of taking the average time of the stop watches or a rerun. Decision must be made before contestant's time is announced.
4. Start/Finish line should be clearly marked with cones. Flour/chalk lines are not recommended.
5. Times will be announced at the completion of each contestant's run.
6. Ties for all placings in timed events will be run off. In the event of a tie in a timed class, the contestant declared the winner in a runoff must run the pattern in not more than two seconds over the original time or the runoff must be held again.
7. No string, rubber bands, or other material to tie feet or legs in stirrups is allowed. The use of any material to affix rider to any part of the saddle is prohibited
8. No rerun will be given to any contestant if handicapped by failure of personal equipment or accident to horse or rider.
9. Loss of helmet from head while in arena will result in disqualification.
10. Failure to follow or complete course is disqualification.
11. A contestant may touch a barrel(s) or pole(s) with his or her hands.
12. Striking a horse in front of cinch with anything other than the open hand is a disqualification. Striking the horse with anything including hand, in front of the throat latch is a disqualification.

KEYHOLE RACE, Class 26-27

1. Time starts as the contestant crosses the start-finish line, which should be designated by markers. Contestant shall proceed through the five-foot entrance, turn right or left in the circle, return through the entrance and cross the start-finish line between markers. Time stops as the contestant crosses the start-finish line.

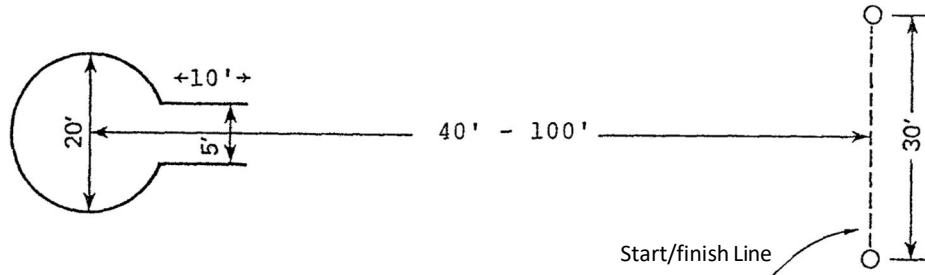

2. The starting line shall be 40 to 100 feet (according to arena size) from the entrance to the keyhole.
3. The entrance shall be 5 feet wide and 10 feet long, connected to a circle 20 feet in diameter.
4. A contestant is disqualified if a horse steps on or outside the markings of the circle or the opening or fails to cross start-finish line between markers.
5. Lime or flour is suggested to lay out the patterns.

STAKE RACE, Class 28-29

1. The contestant is allowed a running start. Timing shall begin as soon as the horse's nose reaches the start line and will be stopped when the horse's nose passes over the finish line. Start by crossing start line between start/finish markers. Contestant must cross center line (dotted) when going to first end pole. At the first pole, contestant may go right or left. Between first turn and second turn horse must cross center line (dotted). The second turn MUST be opposite the first turn. Finish by crossing or not crossing center (dotted) line between start/finish markers.
2. Upright end poles are set 40 feet on each side of the start/finish line. Two upright markers will be placed on the start/finish line (10 feet on each side of the dotted center line). If an electric timer is used, it is suggested that rubber cones, short enough so as not to interfere with the timer, be used.

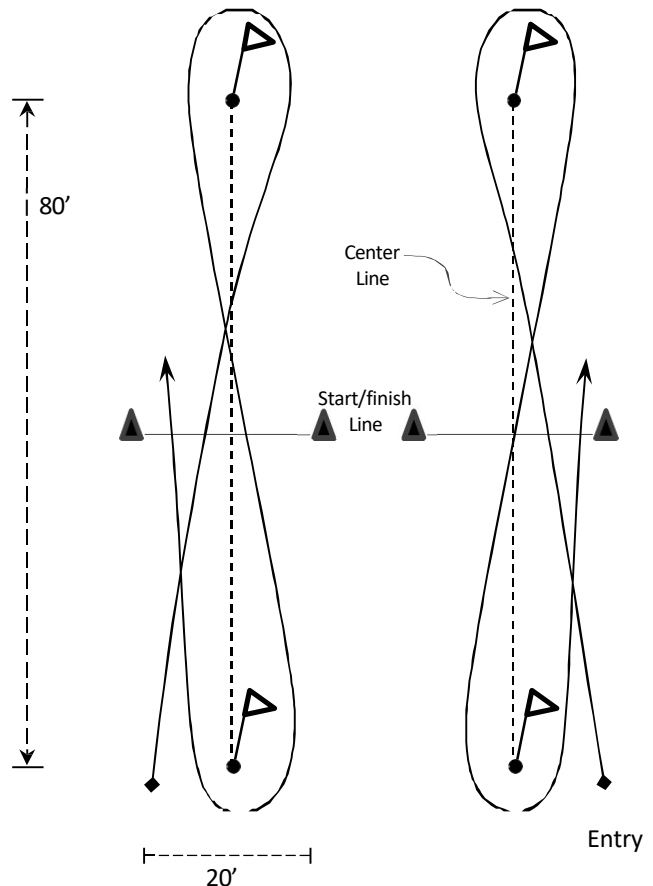

3. Failure of contestant to cross start/finish line between markers will result in disqualification.
4. Knocking over pole or any start/finish marker constitutes a five (5) second penalty.

POLE BENDING, Classes 30-31

1. The pole bending pattern is to be run around six poles. Each pole is to be 21 feet apart, and the first pole is to be 21 feet from the starting line.
2. A horse may start either to the right or to the left of the first pole and then run the remainder of the pattern accordingly.
3. Knocking over a pole constitutes a five (5) second penalty.

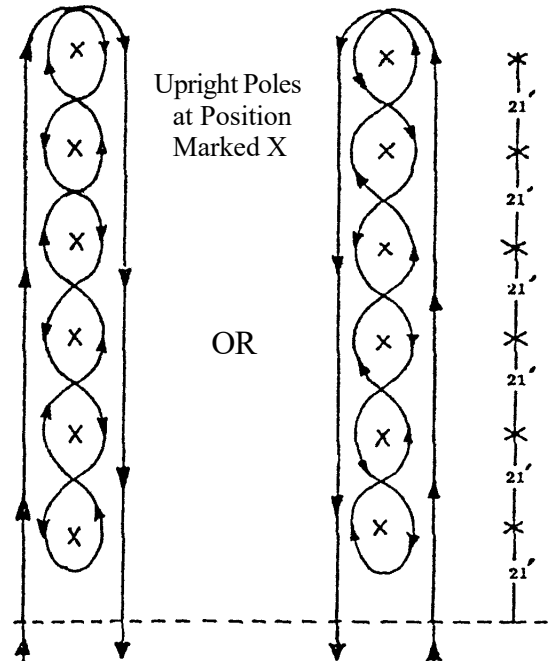

BARREL RACE, Classes 32-33

1. The course must be measured exactly. If the course is too large for the available space, then the distance between the barrels should be reduced five yards at a time until the pattern fits the arena. The distance from barrel number 3 to the finish line need not be reduced five yards at a time if there is sufficient room for the horse to stop. Remember to leave adequate space between barrels and obstacles. First and second barrel should be at least 20 feet from fence.
2. At a signal from the starter, the contestant will run to barrel number 1, pass to the left of it, and complete a slightly more than 180 degree turn around it; then go to barrel number 2, pass to the right of it, and complete a slightly more than 180 degree turn around it; then go to barrel 3, pass to the right of it, and turn approximately 180 degrees around it; and then sprint to the finish line passing between barrels 1 and 2.
3. This barrel course may also be run to the left. For example, the contestant will start to barrel number 2, turning to the left around this barrel, then to barrel number 1, turning to the right, then to barrel number 3, turning to the right, followed by the final sprint to the finish line.
4. Each barrel knocked over shall carry a five (5) second penalty

ACCEPTABLE BARREL RACE PATTERNS

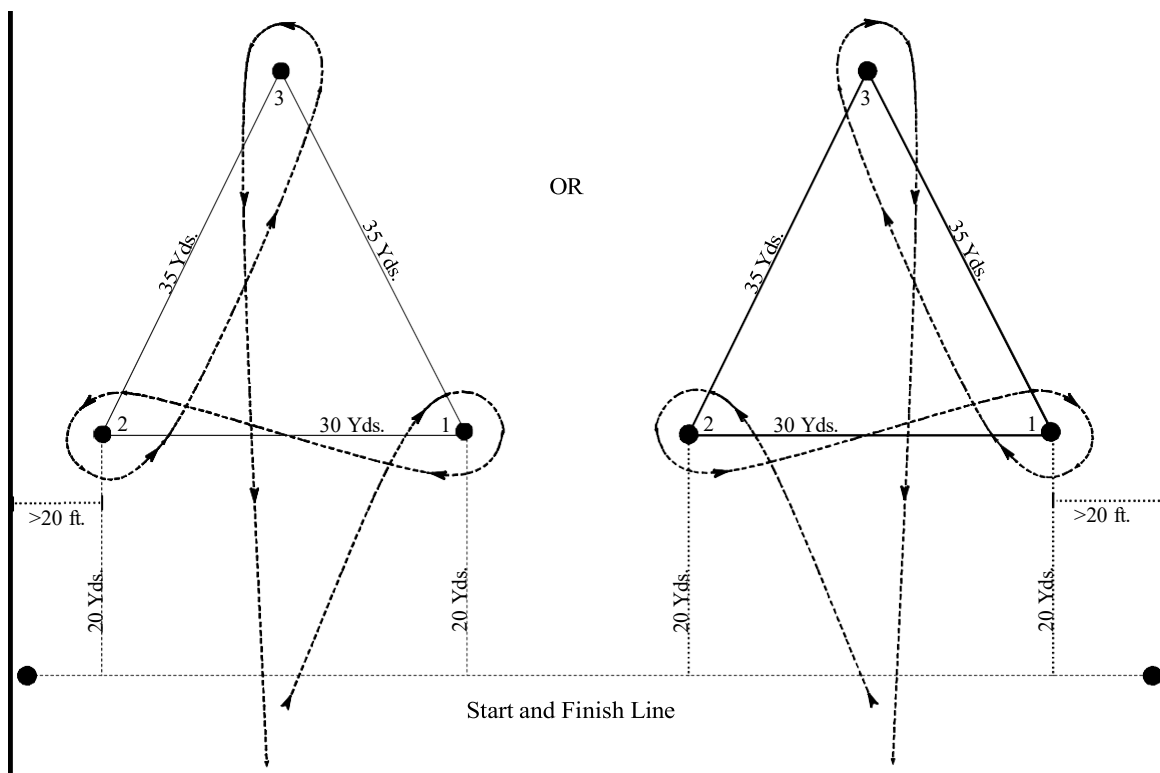

HUNTER DIVISION (Classes 34–50)

APPOINTMENTS:

PERSONAL: All exhibitors are required to wear an SEI or SEI/ASTM approved equestrian safety helmet with fastened chin harness in every class (see rule #6 on page 7). Clothing must be clean, neat, and appropriate for hunter classes. Rider must wear shirt with choker, tie or fastened integrated collar; coat; boots (no tennis shoes or sport shoes are acceptable); and breeches. When management permits riders to ride without jackets, riders must wear traditional, short, or long-sleeved riding shirts without chokers or ties or with integrated collars either fastened or unfastened. Polo shirts are not permitted except in unjudged warm-up (schooling) classes. Unroweled spurs measuring no longer than one inch (where rowel is defined as a flat disc with or without points), spurs with a smooth rolling rubber or stainless-steel ball, gloves, crops, or bats are optional (no whips except in Dressage classes). When riding over fences a crop may be used on the horse's shoulder. Under no conditions may the rider strike the horse with the crop in front of the shoulder. Gloves are preferred in the equitation and dressage classes.

TACK: Clean English forward, hunting, or dressage type saddles. Saddles may have suede seat and/or suede inserts on the skirts. In Equitation classes, it is recommended that riders use traditional stainless steel stirrup irons that allow judges a clear and unobstructed view of the position of the foot in the stirrup. Judges may not eliminate a rider for using a particular style of stirrup iron. Iron or stirrup leather may not be connected to the girth by string or any other material. **See Bits section (page 13) for description of legal bits for Hunter Division.** All bridles must have a cavesson nosebands and plain

leather browbands. Pelham bridles must have two sets of reins attached (pelham connectors not allowed). Breast plates are optional. **Standing martingales are optional in over fence classes (Working Hunter, Equitation Over Fences, and Handy Hunter) except for Hunter Hack. Martingales are not allowed in any under saddle flat classes, or classes that have a flat portion such as Hunter Hack.** Draw reins and hackamores are not permitted. No boots below the fetlock will be permitted in any class. Boots confined to the cannon area will be permitted only in equitation over fences classes. No figure 8, flash, drop, or any other style of nose band that includes a strap which fastens in front of the bit are allowed in Hunter Classes. **Refer to Dressage Appointments (pg. 79) for exceptions to the above and/or for additional requirements.**

HUNTER UNDER SADDLE, Classes 39–41

1. The class will be judged on the horse's way of going, manners, and suitability. Conformation of the horse may only be considered in extremely close competition.
2. Horses enter the ring at a trot and are shown on the flat at a walk, trot, and canter while maintaining light contact with the horse's mouth. They may also be asked to lengthen their stride at the walk, trot, or canter, one or both ways of the ring. An extension is an obvious lengthening of the stride with a slight increase of pace while exerting less effort and appears smooth to ride.
3. Horses must work both ways of the ring at all gaits to demonstrate their ability with different leads.
4. The judge may ask finalists for a hand gallop but never more than a safe number of horses to gallop at one time.
5. Horses should back easily and stand quietly. The judge may ask that only the finalist be backed.

HUNT SEAT EQUITATION ON THE FLAT, Classes 42–43

1. The rider's performance and skills are being judged in this class. Rider's basic position in the saddle, position and use of hands, legs and feet, ability to control and show a horse, and suitability of horse to rider are important, but rider's skills and execution must be considered.
2. Riders will not be required to jump.
3. Position:
 - A. **General Appearance:** Rider should have workmanlike appearance, with light and supple seat and hands, which conveys the impression of complete control should any emergency arise.
 - B. **Basic Position:** Eyes should be up and shoulders back. Toes should be out at angle best suited to rider's conformation; ankles flexed in, heels down, calf in contact with horse and slightly behind girth. Iron may be either under the toe, ball of the foot, or slightly behind ball of the foot.
 - C. **Position in Motion:** At the walk and slow trot, body should be vertical; posting trot, inclined forward; canter, halfway between posting trot and walk; galloping and jumping, same inclination as posting trot.

- D. Hands: Hands should be over and in front of the horse's withers, knuckles thirty degrees inside the vertical with hands making a straight line from horse's mouth to rider's elbow. Hands should not be held tightly together. Method of holding reins is optional and the bight of reins may fall on either side, but it is more acceptable for the bight of the reins to lie on the off side. However, all reins must be picked up at the same time. The rider should maintain light contact with the horse's mouth at all times except when standing still.
- E. Reins: The rein of a snaffle bridle may be held either outside the little finger or between the third and little finger. The snaffle rein of a pelham or full bridle should be held outside the little finger and curb rein between the third and little finger or between the second and third fingers. In either case, reins should be picked up at the buckles by the right hand, then straightened and separated in correct order by the fingers of the left hand, pulled taut, and adjusted to even pressure in both hands.
4. Each rider will individually perform a given pattern which may be composed from the optional list of tests below. The judge will score each rider on his/her individual skills and execution of the pattern. Failure to execute or complete the pattern will not be a disqualification but shall be scored accordingly. Optional list of tests for Hunters which may be executed collectively or individually follows (Junior division riders may be tested using A through J, and Senior division riders may be tested using A through L.):
- A. Perform gaits in straight lines, curves, circles, or any combination to create additional shapes.
 - B. Execute a slow sitting trot, posting trot, and/or extended trot.
 - C. Back.
 - D. Walk from a gallop with the emphasis on hands.
 - E. Halt from a canter.
 - F. Dismount and mount.
 - G. Figure 8 at the trot demonstrating the proper change of diagonals. The rider should be on the left diagonal when trotting in a clockwise direction and on the right diagonal when circling counterclockwise. On the left diagonal, the rider will be sitting in the saddle when the horse's left front leg is on the ground. The rider is on the right diagonal when sitting in the saddle when the horse's right front leg is on the ground.
 - H. Figure 8 at canter demonstrating a simple change of leads (horse is brought back into a walk or trot before being restarted in a canter on the opposite lead.) Figures should be started at the center of the two circles so that one change of lead is shown.
 - I. Ride without stirrups.
 - J. Demonstrate up to a half turn on the forehand from the walk or halt, and/or half turn on the haunches from a walk, not the halt.
 - K. *SR only* – Demonstrate a flying change of leads (change leads without slowing down to a walk or trot) as part of a figure 8 or other maneuver at a canter.
 - L. *SR only* – Maintain a counter-canter.
 - M. *SR only* – Demonstrate up to a full turn on forehand from the walk or halt, and/or full turn on the haunches from a walk, not the halt.

5. Finalists will be required to work on the rail at each gait in at least one direction to determine final placings. The riders may be requested to gallop in safe groups and/or perform additional tests.
6. Scoring may be based on a 1 to 20 or 1-100 system. Judging emphasis will be on pattern work, execution, and demonstrated horsemanship/equitation. Placing of ties or close scores may be adjusted on rail work as appropriate. Additional pattern work may be requested in finals.

*When more than one pattern is utilized, all scores are cumulative.

Suggested scoring breakdown (1/2-point increments acceptable):

- 90-100 or 20: Excellent equitation including body position and use of aids. Pattern is performed promptly, precisely, and smoothly.
- 80-89 or 18-19: Generally excellent performance with one minor fault in appearance and position of exhibitor or execution of pattern (performance).
- 70-79 or 16-17: Generally good pattern execution and equitation with one minor fault in precision or execution of the pattern (performance), or appearance and position of exhibitor.
- 60-69 or 14-15: Average pattern that lacks quickness or precision, or rider has obvious equitation flaws that prevent effective equitation or commits two or three minor faults in the performance or appearance and position of exhibitor.
- 50-59 or 12-13: One major fault or several minor faults in the performance and/or appearance and position of exhibitor that precludes effective communication with the horse.
- 40-49 or 10-11: Two major faults or many minor faults in the performance, or appearance and position of exhibitor.
- 30-39 or 6-9: Several major faults or one severe fault performance, or appearance and position of exhibitor. Exhibitor demonstrates a complete lack of riding ability or commits a severe fault in the performance or appearance and position of exhibitor.
- 20-29 or 1-5: Exhibitor commits one or more severe faults in the performance, or appearance and position of exhibitor, but does complete the class and avoids disqualification.

7. Depending on the judge's scoring system preference, the following faults/penalties shall be assessed:

A. Minor faults or three (3) point penalty

- 1) Break of gait at the walk or trot for up to 2 strides
- 2) Over or under turn from 1/8 to 1/4 turn
- 3) Tick or hit of cone
- 4) Missing a diagonal up to 2 strides in the pattern or on the rail

B. Major faults or five (5) point penalty

- 1) Not performing the specific gait or not stopping within 10 feet of designated area
- 2) Incorrect lead or break of gait at the canter (except when correcting an incorrect lead)
- 3) Break of gait at walk or trot for more than 2 strides
- 4) Loss of stirrup
- 5) Head carried too low and/or clearly behind the vertical while the horse is in motion, showing appearance of intimidation

- 6) Obviously looking down to check leads or diagonals
 - 7) Missing a diagonal for more than 2 strides in the pattern or on the rail
- C. Severe faults or ten (10) point penalty
- 1) Loss of rein
 - 2) Use of either hand to instill fear or praise while on pattern or during rail work
 - 3) Holding the saddle with either hand
 - 4) Spurring or use of the crop in front of the girth
 - 5) Blatant disobedience including kicking, pawing, bucking, and rearing
- D. Disqualifications (should not be placed)
- 1) Failure to display correct number in visible manner
 - 2) Willful abuse of horse or schooling
 - 3) Fall by horse or exhibitor
 - 4) Illegal use of hands on reins
 - 5) Use of prohibited equipment
 - 6) Off pattern, including: knocking over or wrong side of cone or marker; never performing a designated gait, lead, or diagonal; over or under turning more than 1/4 turn

FENCE HEIGHT SECTIONS FOR FULL-COURSE OVER-FENCES CLASSES

1. Working Hunter, Equitation Over Fences, and Handy Hunter are each offered within two sections based on fence height.
 - A. Low Section: 2'3"
 - B. Medium/High Section: 2'6" and 2'9"
2. All sections are open to horses and ponies, and riders of any age.
3. A horse/rider combination may show in only one section at any single show.
4. All entries in a section will jump at the height specified for that section.
5. Entrants in the Medium/High Section will choose height for each class at time of registration. Exhibitors may change their height choice at the gate before the class starts.
6. Variations in fence standards may force rails to be lower than the section definition. Rails may be set no more than 2" lower than the defined height, but not higher than the section's height.
7. All trot fences will be set at 2' regardless of horse or pony size.

GENERAL COURSE REQUIREMENTS FOR OVER FENCE CLASSES

Hunter Course Fence Components

1. Fences should be inviting in appearance while maintaining safety of both horse and rider. Fences may be constructed of these components, in any combination, but are not limited to these components:
 - A. Gates
 - B. Flower boxes
 - C. Poles (round or octagon shaped)
 - D. Brush boxes - If no rail is used over the brush box, the height of the fence is measured to the top of the solid portion of the box (not the height of the brush)
 - E. Walls
 - F. Coops
 - G. Planks
 - H. Roll tops
2. All fences must have a groundline. Groundlines help both the horse and rider determine the height of the fence and the appropriate takeoff point on the approach to the fence.
 - A. Groundlines may be either a single pole, flower box, brush box or natural brush set in front of the fence.
 - B. Groundlines should never be used on the back side of a fence unless the fence is designed to be jumped both directions. In that case, care should be given when placing the groundlines in order for the horse to not accidentally land on it and cause harm to himself or the rider.

Line Distances

1. The basic average horse (over 14.2h) stride is 12' long. Lines designed for four (4) horse strides or more should be built on intervals of 12' as follows:
 - 4 strides = 60'
 - 5 strides = 72'
 - 6 strides = 84'
 - 7 strides = 96'
2. Lines longer than 100' are not equated to strides but are a test of the rider's ability to reach the second fence at a comfortable distance for takeoff.
3. Large ponies with a stride length less than 12' will likely add 1 stride down lines set on 12' increments. And small/medium ponies will likely add 2 and maybe even 3 strides down lines set on 12' increments.
4. These line distances are just a general guide and may vary by 6" to 12" depending on arena footing, size of the arena, whether it is an indoor or outdoor arena, and level of the competitors. Also, a distance will normally ride easier when traveling toward the in-gate or going downhill.
5. Line distances are measured from the backside of the first jump to the front rail of the next jump.
6. Three (3) stride lines should be adjusted for size of the horse as follows:
 - Horse = 47' - 48'
 - Large Pony = 44' - 46'
 - Small/Medium Pony = 40' - 42'
7. In a three (3) stride line, each fence is numbered sequentially. In the case of a refusal or runout at the second fence of the 3-stride line, the exhibitor will retake only the fence where the fault occurred.

In and Out Elements

1. An In and Out is defined as two jumps set for one (1) or (2) strides. The distance must be adjusted for size of horse as follows:
 - A. One Stride
 - Horse = 24' - 26'
 - Large Pony = 22' - 24'
 - Small/Medium Pony = 20' - 22'
 - B. Two Stride
 - Horse = 34' - 36'
 - Large Pony = 32' - 34'
 - Small/Medium Pony = 30' - 32'
2. Normal guidelines for In and Outs are Vertical to Oxer. In and Outs must never be used as the first fence in any course. In and Outs may not be used in a Working Hunter Class.
3. All In and Outs must be labeled with a single number and the designation of A and B on the course diagram. In the case of a refusal or runout at the B fence, the exhibitor must retake the A fence of the In and Out.

Oxer Elements

1. Oxers are fences that have depth as well as height. Oxers must be set ascending with the back rail 3" to 6" higher than the front rail.
2. The spread of the oxer is measured horizontally from the front most element of the oxer to the back edge of the back rail. The allowed maximum distance for the spread is 2'3" and cannot be wider than the height of the fence.
3. Oxers are typically set as the second fence in a line but may also be set as a single fence on the course. Oxers should never be used as the first fence in any course.

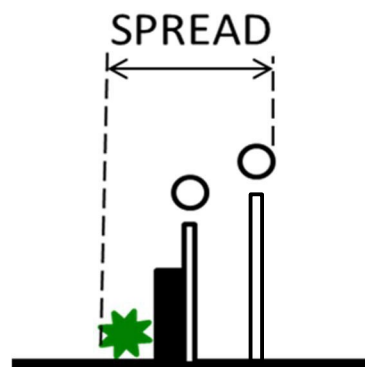

HUNTER HACK, Class 44

1. The class will be open to horses or ponies. The class will be judged on the horse or pony's way of going, manners, suitability, and style of jumping.
2. All riders entering this class will jump two fences first; then only finalists as selected by the judge will work on the flat at a walk, trot, and canter in both directions.
3. The second jump element of a line may be an oxer.
4. There will be a choice of fence height. Rider may elect to jump 2' 3" or 2' 6".
5. Judge has the option of asking for a hand gallop and/or halt in either the flat or jumping phase. No more than eight at a time will be asked to gallop.
6. Three cumulative disobediences, a fall of horse and/or rider, or going off course disqualifies the entry from the entire class. Dismissed contestants will exit promptly.

7. Placing for the class shall be determined by judging 70 percent on individual fence work and 30 percent on flat work.
8. No martingales of any type will be allowed in either phase.

WORKING HUNTER, Low and Medium/High, Classes 45 and 48

1. Horses will be judged on performance, manners, hunting pace, style of jumping, way of moving, and suitability for actual use in the hunting field.
2. All horses must be serviceably sound. Horses will perform a courtesy circle at a trot at the end of their trip. Any horse showing lameness, broken wind, or impairment of vision as determined by the judge will be disqualified.
3. Each horse will individually negotiate a course consisting of at least eight jumping efforts with a minimum of four obstacles. At least two changes of direction are recommended. Judging will start when the horse enters the arena and ends when the horse leaves the arena.
4. Management should provide at least two practice jumps. These jumps should be in a warm-up ring or area.
5. Judging-General:
 - A. All classes must be judged on performance and soundness and when indicated, conformation, suitability, or manners.
 - B. Judges must penalize unsafe jumping and bad form over fences, whether touched or untouched.
 - C. Circling once upon entering the ring and once upon leaving is permissible.
 - D. When a horse makes two faults at an obstacle, only the major fault on the top element will be scored (exception: refusals count in addition).
 - E. When an obstacle is composed of several elements in the same vertical plane, a fault at the top element is the only one penalized.
 - F. Dismissed contestants will exit promptly.
6. Faults:
 - A. Minor or Major Faults
 - (1) Showing an obstacle to a horse
 - (2) Missing a lead change
 - (3) Kicking out
 - (4) Spooking
 - (5) Jumping out of form
 - (6) Jumping into corners of obstacle

B. Major Faults

- (1) Knock down of any part of an obstacle
- (2) Refusals
- (3) Trotting while on course when it is not specified
- (4) Bucking
- (5) Stopping for loss of shoe or broken equipment
- (6) Circling while on course
- (7) Dangerous jumping

C. Elimination-

- (1) Three refusals
- (2) Off course
- (3) Jumping a fence before it is reset
- (4) Bolting from the ring
- (5) Fall of horse or rider

D. The following may or may not be considered as faults, depending on their severity and frequency:

- (1) Light rubs
- (2) Swapping leads in a line
- (3) Late lead changes
- (4) Excessive show of animation
- (5) Adding or eliminating a stride in a line

EQUITATION OVER FENCES, Low and Medium/High, Classes 46 and 49

1. Rules for equitation over fences are the same as equitation on the flat, only the tests differ. Riders enter ring and perform a test over fences.
2. Except for refusals, jumping faults are not considered unless it is the result of the rider's ability.
3. The following will result in elimination: fall of horse and/or rider; three cumulative refusals, and/or off course.
4. The following constitute major faults and can be cause for elimination: a refusal, loss of stirrup, trotting while on course when not part of a test, and/or loss of reins.
5. After the class has individually completed the course, finalists may be asked to re-enter the ring and perform a series of tests or rail work to break ties and determine final placings. These tests may be the same as equitation on the flat with the addition of the following:
 - A. Jump low fences at walk, trot, or canter, depending on judge's discretion.
 - B. Pull up between fences except in combination.
 - C. Jump fences on a figure-of-eight course.
 - D. Jump serpentine course, demonstrating simple change of lead.

HANDY HUNTER, Low and Medium/High, Classes 47 and 50

1. Horses will be judged on performance, manners, hunting pace, style of jumping, way of moving, and suitability for actual use on a trappy hunting field.
2. All horses must be serviceably sound. Horses will perform a courtesy circle at a trot at the end of their trip. Any horse showing lameness, broken wind, or impairment of vision as determined by the judge will be disqualified.
3. Each horse will negotiate a course consisting of at least eight jumping efforts with a minimum of four obstacles. At least two changes of direction are required.
 - A. One In and Out jump may be included in the course.
 - B. Horses are required to trot over one fence toward the end of the course.
 - C. Judging will start when the horse enters the arena and ends when the horse leaves the arena.
4. Management must provide at least two practice jumps in a warmup ring or area.
5. Judging-General:
 - A. All classes must be judged on performance and soundness and when indicated, conformation, suitability, or manners.
 - B. Judges must penalize unsafe jumping and bad form over fences, whether touched or untouched.
 - C. Circling once upon entering the ring and once upon leaving is permissible.
 - D. When a horse makes two faults at an obstacle, only the major fault on the top element will be scored (exception: refusals count in addition).
 - E. When an obstacle is composed of several elements in the same vertical plane, a fault at the top element is the only one penalized.
 - F. At an In and Out, the faults committed at each fence are considered separately.
 - G. Dismissed contestants will exit promptly.
6. Faults:
 - A. Minor or Major Faults-
 - (1) Showing an obstacle to a horse
 - (2) Missing a lead change
 - (3) Kicking out
 - (4) Spooking
 - (5) Jumping out of form
 - (6) Jumping into corners of obstacle

B. Major Faults-

- (1) Knock down of any part of an obstacle
- (2) Refusals
- (3) Trotting while on course when it is not specified
- (4) Bucking
- (5) Stopping for loss of shoe or broken equipment
- (6) Circling while on course
- (7) Dangerous jumping

C. Elimination-

- (1) Three refusals
- (2) Off course
- (3) Jumping a fence before it is reset
- (4) Bolting from the ring
- (5) Fall of horse or rider

D. The following may or may not be considered as faults, depending on their severity and frequency:

- (1) Light rubs
- (2) Swapping leads in a line
- (3) Late lead changes
- (4) Excessive show of animation
- (5) Adding or eliminating a stride in a line

DRESSAGE DIVISION (Classes 51–55)

WESTERN DRESSAGE, Classes 51–52

APPOINTMENTS: See the Appointments for the Western Division for the basis of allowable Western tack and attire, and the General Rules for Western bits. Additions/exceptions are:

PERSONAL: Spurs are optional and may be of Western style, with or without blunt tines, or English Dressage style. Other optional attire includes chaps, gloves, necktie or similar tie/pin, vest, jacket, coat, or sweater.

TACK: The following exceptions and/or additions are allowed in Western Dressage:

1. Western cavesson on the bridle (braided or plain) with space for two fingers between the cavesson and horse's jowl. No metal, studs, or rigid material may be part of the cavesson. No flash, figure-8, or dropped nose bands.
2. Bits/bridles that may be used on horses of any age:
 - A. Snaffle bit (as defined in Western Bits).
 - B. Hackamore (Bosal, as defined in Western Bits).
 - C. Bitless bridle. Must be Western style made of leather or leather-like material.

3. Breastplate and/or crupper.
4. One whip no longer than 47.2 inches (120cm) including lash.
5. Standard stock saddle is customary, but a working saddle, Aussie, and Western side saddle are also acceptable. A horn is optional but Western style fenders are required. Padding on the saddle's seat and tapaderos are permitted.
6. Reins:
 - A. With snaffle bit: loop/connected reins, split reins, buckled reins, mecate reins, or Romal reins without a popper; two hands must be used with any of these combinations.
 - B. With bosal: Horsehair, rope reins and mecate reins; two hands must be used. The mecate can be tied to the saddle horn or held by the rider.
 - C. With curb: Romal reins or Split reins. When using a curb with Romal reins, only one hand is allowed; when using split reins, one or two hands are allowed.
7. Hand position on reins:
 - A. Romal reins: the Romal is held in one hand with no fingers between the individual reins. The end of the Romal may be held in the hand not used for reining to keep the Romal from swinging and to adjust the position of the rein. The reins must be held so that there is at least 16" of rein between the hands.
 - B. Split reins: When split reins are held in one or two hands, the rider may not switch back and forth during a test. When the split reins are held in one hand, there are two ways that the rider may use them:
 - (1) with one finger between the split reins; the ends of the reins fall on the side of the reining hand.
 - (2) without a finger between the reins; the hand must be around the reins. The ends of the Split reins may be held in the hand not used for reining to keep them from swinging and to adjust the position of the reins. The reins must be held so that there is at least 16" of rein between the hands.
 - C. At the end of the Free Walk or Free Jog, riders using split reins held in one hand may use the free or offhand to pull the reins back to the desired length. Riders using Romal reins may use the hand using the Romal to alter the tension or length of the reins from the bridle to the reining hand.

In addition to what is described in Appointments for the Western Division, the following are not allowed in Western Dressage:

1. Full cheeks, half cheeks, kimberwicks, roping bits with both reins attached to a single ring, or any type of rein or attachment which increases the effective length of the bit's shank or creates additional leverage.
2. Round, rolled, braided, or rawhide curb straps.
3. Martingales, bit guards, any kind of gadgets (such as bearing, side, running, balancing reins, nasal strips, tongue tied down, etc.), any kind of boots (including "easy-boots," splint/hock/bell boots,

etc.), tail bandages, any form of blinkers, ear muffs or plugs, and nose covers.

EXECUTION AND JUDGING OF TESTS:

1. Western Dressage integrates the historically validated principles of dressage with the best of western stock horse tradition, with the purpose of enjoying a safe, pleasurable, versatile, and useful working horse. The hallmarks of the Western Dressage Horse are usefulness, rideability, willingness, safety, pure gaits, lightness, calmness, and steadiness. A Western Dressage Rider should use clear, effective, subtle aids coupled with a confident seat and light, responsive hands in communication with the horse.

A Western Dressage Partnership should exhibit impulsion originating from deeply engaged hindquarters transmitted without resistance through a supple topline to a light, soft contact with the rider's hand(s). The horse should move freely forward via a willingness to work off the hindquarters which enables the western horse to be a useful working partner.

2. Gaited horse will perform a saddle gait in place of the jog. The saddle gait selected should be the gait in which the gaited horse is balanced and athletically comfortable performing. The saddle gait is a 4-beat lateral or diagonal gait, timely and evenly performed. The tempo, rhythm, and foot falls of the gait they choose to show must not change throughout the test. The true four beat gait the horse performs should be able to be ridden in a working, lengthened, free and collected manner as called for in the Western Dressage test.
3. See the USEF Rulebook (www.usef.org) for further explanations of the general principles of Western Dressage competition and the correct gaits (including for gaited horses) and movements.
4. The dressage test used will be selected annually. See class list for current test.
5. Arena size may be either 20m X 40m or 20m X 60m (see pg. 80 for layouts).
6. Approximately 6-8 minutes will be allowed for each test. The specific time limit will be based on the test selected. Show management reserves the right to adjust individual ride times under extenuating circumstances.
7. A competitor who does not enter the arena within 45 seconds after the entry bell or whistle has sounded shall be eliminated.
8. Tests may be called during the competition. If tests are announced, it is the responsibility of the competitor to arrange for a person to announce the test. Lateness and errors in announcing the ride will not relieve the rider from "error penalties." Announcing the test is limited to reading the movement as it is written once only. However, the repetition of reading of a movement is acceptable if there is reason to doubt that the rider heard the original call.
9. Voice: The quiet use of the voice or clicking the tongue once or repeatedly is permitted.
Touch: Petting the horse is allowed during the test as a gentle reward.
10. When a competitor makes an "error of the course" (takes the wrong turn, omits a movement, etc.) the judge warns him by sounding the bell or whistle. The judge shows him, if necessary, the point at which he must take up the test again and the next movement to be executed then leaves him to continue by himself.
11. The score for each movement should first establish the fact of whether the movement is performed

insufficiently (4 or below) or sufficiently (5 or above). The scoring scale is:

10 - Excellent	6 - Satisfactory	2 - Bad
9 - Very Good	5 - Marginal	1 - Very Bad
8 - Good	4 - Insufficient	0 - Not executed
7 - Fairly Good	3 - Fairly Bad	

12. In the case of a fall of horse and/or rider the competitor will be eliminated.
13. If during the test (between the time of entry and the time of exit at A) the horse leaves the arena (all four feet outside the fence or line marking the arena perimeter) the competitor is eliminated.
14. Resistance of the horse which prevents continuation of the test for longer than 20 seconds results in elimination.
15. In the case of equality of percentage, the competitor with the highest sum of the Collective Marks shall be declared the winner of the tie. Errors on a test may not be used to break ties. If this procedure does not break the tie, then the tie is broken by the judge.
16. A competitor may enter and ride in the perimeter area surrounding the dressage arena, or within the dressage arena if space is not sufficient around the perimeter, immediately prior to his/her ride and after the final salute of the previous competitor.

TRAINING LEVEL, Classes 53–54; and FIRST LEVEL, Class 55

APPOINTMENTS:

PERSONAL: Personal appointments will be as described in the Hunter Appointments section (pg. 69). In addition, dressage whips are optional and may be no longer than 47.2 inches (120 cm) including lash.

TACK: Any English-type of saddle may be used (i.e., dressage, forward seat, flat, or cut back). A plain snaffle bridle is required with a regular cavesson, or a dropped, a flash, or a figure-8 noseband. **See Bits section (page 13-14) for description of legal bits for Dressage.** Except for buckles and a small disk of sheepskin, which may be used in the intersection of the two leather straps of a figure-8 noseband, the noseband must be made entirely of leather or leather-like material. A padded noseband is allowed.

Martingales, bit guards, any kind of gadgets (such as bearing, side, running, balancing reins, nasal strips, tongue tied down, etc.), any kind of boots (including “easy-boots”) or bandages (including tail bandages) and any form of blinkers, earmuffs or plugs, nose covers, seat covers, hoods are prohibited. Tack may be inspected prior to competition. Unauthorized tack will be removed, or contestant will be disqualified.

USEF/USDF TESTS USED: Jr. Training Level – 2023 Training Level Test of Choice
Sr. Training Level – 2023 Training Level Test of Choice
First Level (all ages) – 2023 First Level Test of Choice

1. The purpose is to test the rider and horse on the basic principles of dressage competition.
2. An exhibitor may enter one Training Level class and one First Level class.
3. Approximately 5–10 minutes will be allowed for each test. This includes warm up time prior to riding test. Specific time limit to be determined based on test used.

4. Rider must enter within 45 seconds after whistle or bell has been sounded. A salute to the judge is required but does not entail the removal of the hat.
5. A competitor may enter and ride in the perimeter area surrounding the dressage arena, or within the dressage arena if space is not sufficient around the perimeter, immediately prior to his/her ride and after the final salute of the previous competitor.
6. In the case of equality of percentage, the competitor with the highest sum of the Collective Marks shall be declared the winner of the tie. Errors on a test may not be used to break ties. If this procedure does not break the tie, then the tie is broken by the judge.

Scoring:

10 - Excellent

9 - Very Good

8 - Good

7 - Fairly Good

6 - Satisfactory

5 - Marginal

4 - Insufficient

3 - Fairly Bad

2 - Bad

1 - Very Bad

0 - Not executed

Penalties:

1st error - 2 points

2nd error - 4 points

3rd error - elimination

Arena size for dressage may be either 20 m x 40 m or 20 m x 60 m.

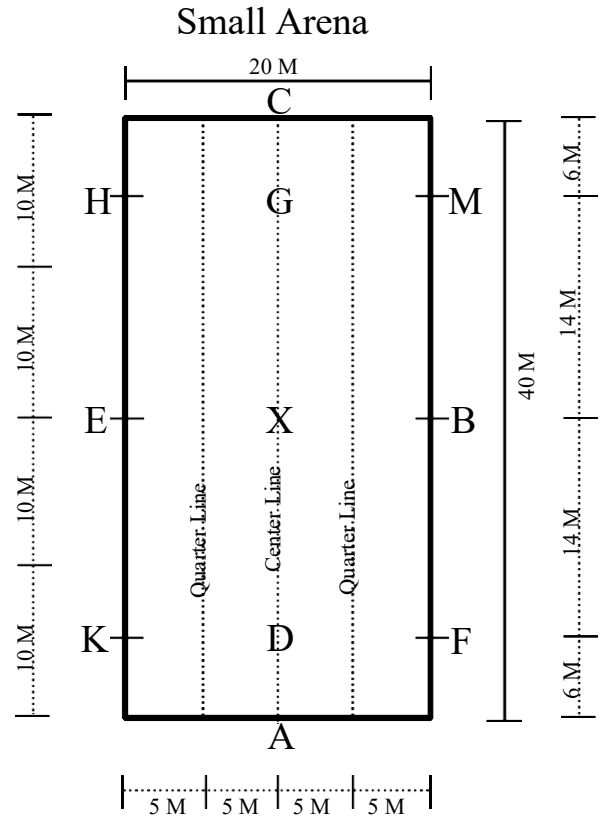
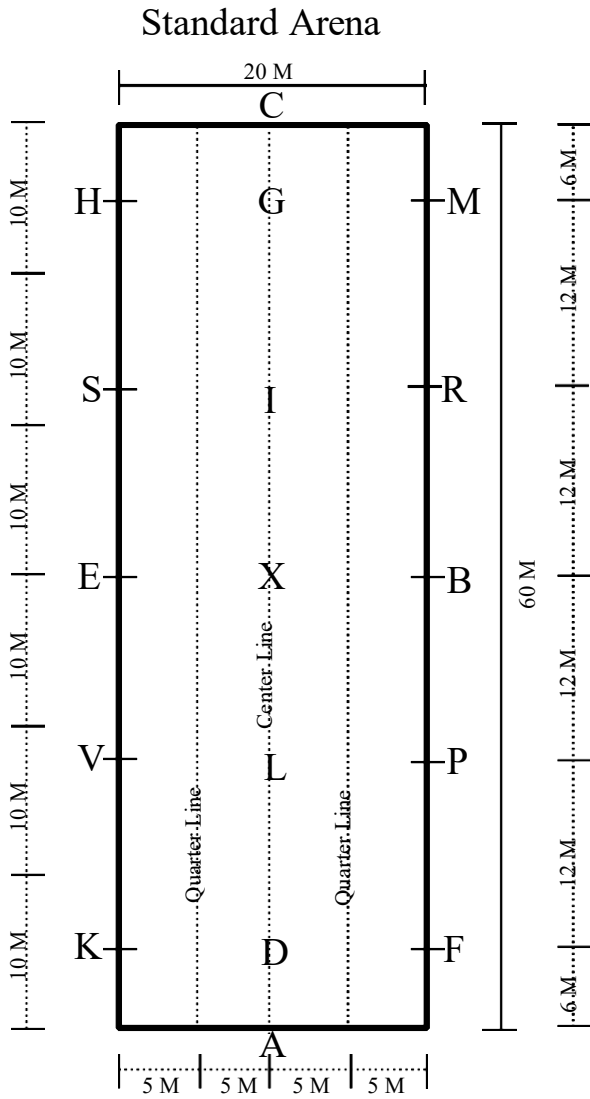

GENERAL SHOW MANAGEMENT CONSIDERATIONS

A smooth-running show is the result of careful planning and delegation of responsibilities to capable and reliable individuals. After the date and location of the show has been determined, the show management should appoint committees or individuals to assume definite responsibilities. The following suggestions are offered for your information and consideration.

1. Committees
 - A. Finance
 - B. Entries
 - C. Publicity
 - D. Equipment
 - E. Trophies and ribbons
 - F. Grounds and facilities
 - G. Premium list and program
 - H. Information
 - I. Appeals committee
2. Show Officials
 - A. Judge
 - B. Clerks
 - C. Announcer
 - D. Ring Steward
 - E. Superintendent
 - F. Arena gate people
 - G. Timer
3. Work Details
 - A. Program sale
 - B. Gate and ticket sale
 - C. Stall assignment and housing
 - D. Food concessions
 - E. Decorations
 - F. Arena maintenance
 - G. Clean up
 - H. Registration
 - I. Awards presentation
4. Protection
 - A. First Aid
 - B. Ambulance
 - C. Fire protection
 - D. Police protection
 - E. Employer's and public liability insurance
 - F. Veterinarian
5. Suggested Check Points
 - A. Public announcement should be made well in advance giving the name of the judge, date, time, and location of the show. It should also tell when, where, and how participants are to enter.
 - B. Every show announcement should carry a full description of the show and events.
 - C. Diagrams of all courses and conditions of the classes should be available to the contestants before the class, i.e., these diagrams and conditions should be posted in the appropriate areas.
 - D. All listed equipment and facilities are subject to availability.
 - (1) Show management should make every effort to see that the conditions are the best possible. It is suggested the facilities be in good repair and the arena be worked, leveled, and mowed.
 - (2) Show arena of adequate size and conditions.
 - (3) Equipment and seating for exhibitors.
 - (4) Parking and seating for spectators.
 - (5) Exercise area for use by exhibitors.
 - (6) Restrooms, food, drinking water and other considerations for the comfort of exhibitors and spectators.
 - (7) Stalls or tie rails for horses entered.
 - (8) Trailer parking.
 - (9) Water, feed, and hay.
 - (10) Public address system for exhibitors as well as spectators.

- E. Questions regarding conduct of the show should be referred immediately to the superintendent of the show. He/she should confer with other show officials or judges, if necessary, and give an on-the-spot decision that shall be accepted as final. A designated appeals or executive committee is desirable.
 - F. An explanation of proceedings should be carried over the public address system while the show is in progress to inform the public of events being conducted.
 - G. All decisions of the judge will be considered final. Judges should be encouraged to give reasons for final placings.
 - H. Where the number of entries is large, the management should reserve the right to have preliminary selections made in any class, to further divide the class on the basis of height and/or types of horses entered or combine certain classes if the need arises.
 - I. Classes should be entered well in advance of the show or events, with no post entries accepted. No refunds should be made after entries close.
 - J. Each class should be called at least two times before the "last call."
 - K. A 4-H statement of understanding/permission form signed by a parent or guardian shall be required of all participants at time of entry.
 - L. Each rider should be identified by large numbers.
 - M. Good sportsmanship should be stressed at all times.
6. Guidelines for Area 4-H Horse Show Committees
- Area 4-H Horse Shows have divided responsibility between the state office and area committee.
- A. The State Office shall provide:
 - (1) Judges' fees.
 - (2) Awards, trophies and ribbons.
 - (3) Assistance to show manager prior to show.
 - B. The Area Committee shall provide:
 - (1) Judges
 - (2) Show manager in the form of County Extension Agent.
 - (3) Physical facility (show arena) of adequate size and condition.
 - (4) All paperwork to include entries, class sheets, and results of shows.
 - (5) Poles, barrels, jumps, timer, and markers for reining and western riding.
 - (6) All labor needed to include grounds crew, arena set up crew, announcer, ring stewards, clerk to assist in recording results of show and qualified person to check appointments.
 - (7) Public address system for exhibitors and spectators.
 - (8) Designated Appeals Committee with a minimum of three (3) members who have a working knowledge of the State 4-H Horse Show Rules. It is suggested that these three people be from different counties.
 - (9) It is suggested that Area Committee review the section of these rules on general horse show management considerations.
 - C. The Division Committees shall provide the design of patterns/courses at least one (1) week prior to the show. Copies of courses/patterns shall be approved by the judge(s) prior to posting.

TOPIC INDEX

- 4-H Emblem Use, 85
 - Age Divisions, 1
 - Age of Horse, 2
 - Attire allowed in-
 - Conformation, 15
 - Dressage, 77
 - Hunter, 67
 - Ranch, 28
 - Showmanship/Ground Handling, 16
 - Speed Events, 63
 - Western, 21
 - Bits
 - Dressage, 13
 - Hunter, 13
 - Ranch, 11
 - Speed Events, 11
 - Western, 11
 - Classes
 - Entry parameters, 4
 - Inclement weather, 8
 - Pattern-class procedures, 10
 - Pleasure-type procedures, 9
 - Timed Event procedures, 63
 - Coaching, 8
 - Condition of Horse, 2, 16
 - Dressage arenas, 82
 - Electric timers, 10, 63
 - Equipment allowed in-
 - Conformation, 15
 - Dressage, 80
 - Hunter, 67
 - Ranch, 28
 - Showmanship/Ground Handling, 16
 - Speed Events, 63
 - Western, 21
 - Western Dressage, 77
 - Fake tails, 9
 - Fall, horse or rider, 9
 - Helmets, 7
 - Horse definition, 2
 - Horse ownership, 2
 - Horse replacement, 2
 - Hunter course parameters/fence heights, 71
 - Lameness, 8
 - Leasing, 2
 - Leg wraps, 10, 63
 - Number Display, 7
 - P.A. system, 7
 - Point system
 - Area, 4
 - Breaking ties, 6
 - State, 5
 - Pony measuring, 9
 - Posting patterns, 10
 - Qualifying
 - Procedure, 4
 - Provisional, 2
 - Rider/Horse, 4
 - Record Book, 2
 - Refunds, 3
 - Regionals Qualifying, 1
 - Speed Event disqualifications, 63
 - Stallions, 4
 - Steps out of bounds, 9
 - Trail obstacles, Ranch, 46
 - Trail obstacles, Western, 25
 - Unsportsmanlike conduct, 8
 - Vaccines, 4
-

USE OF THE NAME AND EMBLEM OF 4-H CLUB WORK

The use of the name and emblem of 4-H Club Work is regulated by Federal Law. This law states that only activities or programs under supervision of the Cooperative Extension Service may use the name and emblem of the 4-H Club Work. Therefore, any local, county, district, area, or state 4-H horse show must have the approval of the Florida Cooperative Extension Service through county, district, or state personnel.

Shows or events sponsored by other organizations or individuals and shows which do not provide separate classes for 4-H members are not permitted to use the name and emblem of the 4-H Club Work. In such cases, the title "Junior Horse Show" or similar name should be used.

JUDGE'S RESPONSIBILITY

Judges for the state 4-H horse shows will be selected and furnished by the State Horse Specialist. Suggestions and recommendations concerning judges are not only welcomed but solicited by the state office.

1. Good judging depends upon the correct observance of horses and/or riders and measuring of them against a standard commonly accepted as the ideal, according to the conditions and description of the class being judged. A judge serves three interests: his/her own conscience, the exhibitor's, and the spectator's. He/she should make clear to the audience that the winners are the best horses and/or riders. Since 4-H club work is a learning experience, the members should be able to follow the judging procedure.
2. A judge must adjudicate each class in conformity with the rules and specifications of the class as they appear in this rulebook.
3. Western judge or person(s) designated by show management will observe speed events to make necessary judgments when required.
4. An exhibitor does not have the right to inspect the judge's cards. However, an exhibitor may request of the Show Committee or stewards the reason for a decision. At a proper time and place, the Show Committee may request the judge to give their reasons. A judge is not to be approached with regard to any decision immediately prior to or while judging.
5. A recorder should be provided by the show management to record judge's comments and maintain scores for all classes when applicable. The judge is still responsible for checking the exhibitor's number while scoring his/her performance. These scores/comments may be made available for exhibitor's inspection at the discretion of show management.

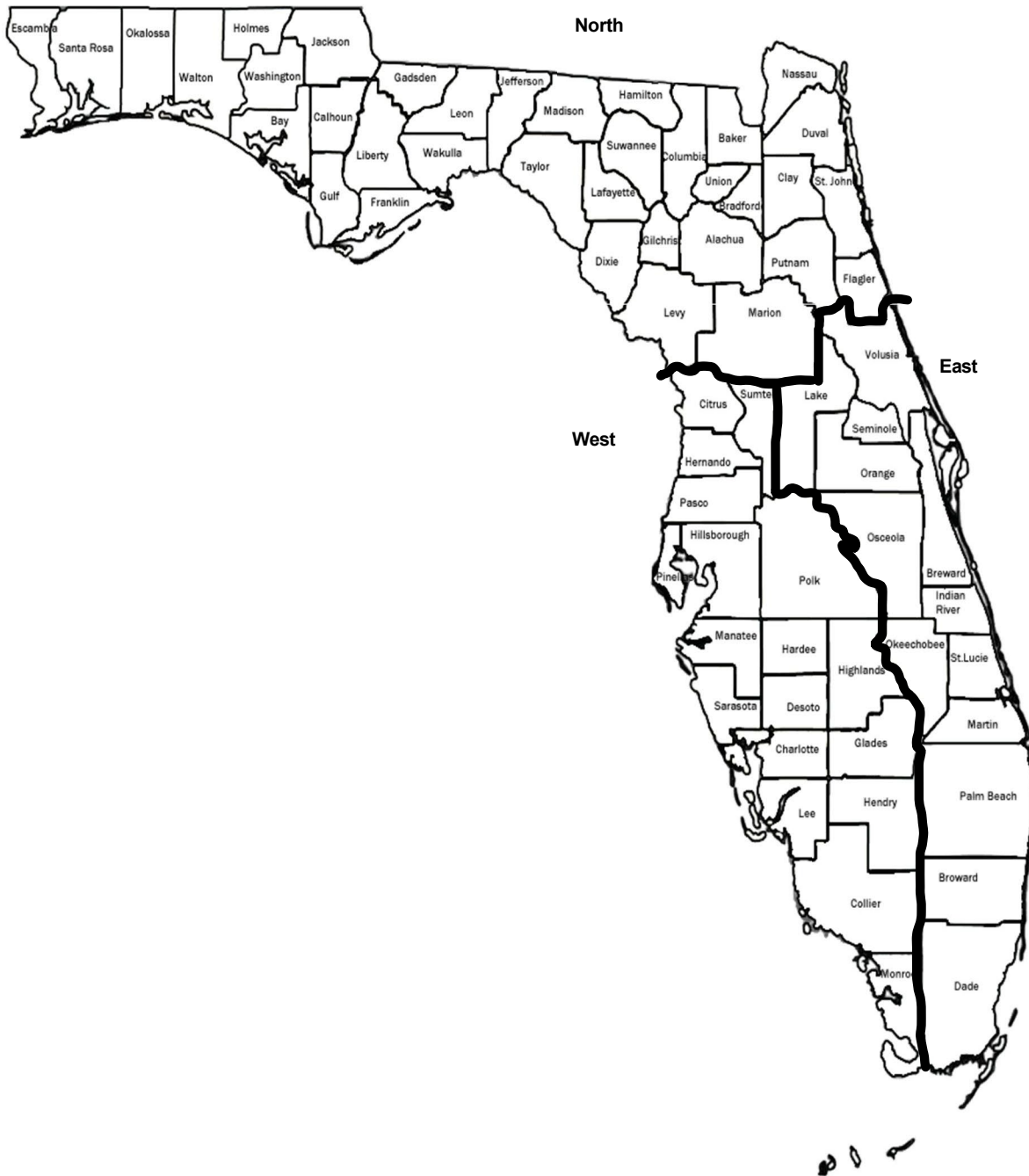

COOPERATIVE EXTENSION SERVICE, UNIVERSITY OF FLORIDA, INSTITUTE OF FOOD AND AGRICULTURAL SCIENCES, Andra Johnson, Director, in cooperation with the United States Department of Agriculture, publishes this information to further the purpose of the May 8 and June 30, 1914 Acts of Congress; and is authorized to provide

research, educational information, and other services only to individuals and institutions that function without discrimination with respect to race, creed, color, religion, age, disability, sex, sexual orientation, marital status, national origin, political opinions, or affiliations. Single copies of extension publications (excluding 4-H and youth publications) are available free to Florida residents from county extension offices. Information about alternate formats is available from IFAS Information and Communication Services, University of Florida, PO Box 110810, Gainesville, FL 32611-0810. Revised January, 2023.